



Biostat® D-DCU

Your "Fast Lane"
To Production

Simplifying Progress

SARTORIUS

Biostat® D-DCU – Your “Fast Lane” To Production

The Biostat® D-DCU is a compact bioprocess system available in microbial or cell culture versions with vessel choices from 10 to 200 L working volume.

The optimized and proven design of the Biostat® D-DCU is the result of thorough analysis of the most required features and functions from over thirty years of stainless steel fermenter | bioreactor design experience. This standardized solution eliminates design times, allows faster delivery, reduces cost, guarantees trouble free operation, and allows for global service support as well as spare part availability.

The Biostat® D-DCU incorporates many desirable and advanced features to fulfill virtually any demand for modern bioprocess application, such as: Automatic Sterilization in Place (SIP), Cleaning in Place (CIP), dual pH and DO measurement capability, lid lifting device, Water Intrusion Test (WIT)-Ready filter housings, dual exhaust filter housing line, tube and shell exhaust cooler, exhaust heater, automatic or manual addition arrays as well as other accessories. Furthermore, the Biostat® D-DCU is designed to interface single-use storage bags for media addition and harvest as well as the Takeone® aseptic sampling system. The modular approach allows multiple configurations (from baseline to fully featured) to meet every need and budget.

Three Subsystems Comprise Every Biostat® D-DCU

- Control tower with integrated gas mixing and pump module
- Culture vessel with bottom agitation system
- Supply Unit, open frame skid and compact stainless steel piping module

The control tower features best-in class control capabilities utilizing proven industrial hardware. It is operated via a simple and intuitive 19” touch screen which keeps staff training to a minimum. The compact design of the stainless steel housing reduces the footprint and saves precious space.

The jacketed stainless steel culture vessel, with spiral baffles for efficient and homogenous heat transfer, are available in 3:1 or 2:1 aspect height to diameter ratio. The gear free bottom drive agitation system provides long-term operation at minimal noise. The zero dead volume sanitary radial diaphragm harvest and radial type sampling valves provide fresh samples without residual pockets and are easy to clean and maintain.

The supply unit includes all process piping for temperature control as well as the exhaust and gas inlet lines. Due to the open frame design direct access for operation and easy maintenance is ensured. Furthermore, minimal floor contact points allow easy cleaning even underneath the skid.

An extended documentation and qualification package is available to support regulatory requirements.

The Biostat® D-DCU is available in both Single and Twin controller configuration. It increases flexibility and allows control of two separate processes at the same time – even with different size culture vessels – but independently from each other.

Features

- Single or Twin Configurations
- Available in incremental sizes from 10 to 200 L
- Preconfigured systems or choose from an extensive list of options
- Powerful industrial rated DCU control system with 19" TFT color touch screen
- Automatic Sterilization in Place (SIP) included
- Automatic Cleaning in Place (CIP) optional
- Designed to interface single-use bags and sampling systems including the new Takeone® aseptic sampling system
- Up to six integrated peristaltic pumps per vessel with options for fixed or variable speed control
- Choice of polarographic or optical DO sensors
- Measurement and control opportunities of pH, DO, temperature, foam, level, vessel pressure, vessel weight, substrate addition, gas mixing, agitation, gravimetric feed and harvest control, constant total gas flow control, redox and turbidity, weight of storage vessels etc.
- Superior gas mixing with up to six flow meters and mass flow controllers
- Extended documentation package available, including logbook and 3-Level password protection
- Minimal floor contact points for ease of cleaning
- Global spare part and service availability



Configure a System Utilizing Options (Like Gasmix, CIP) from a Baseline Unit

Culture Vessel

Available culture vessels from 10 L, 20 L, 30 L, 50 L, 100 L and 200 L working volume, with a total volume aspect ratio of (H:D) 2:1 or 3:1.

Sterilization in Place (SIP)

For ease of operation, automatic sterilization of the culture vessel, gas inlet and exhaust gas flow path are included. Addition groups, sampling valves and drain valves are either manually or automatically sterilized.

Cleaning in Place (CIP)

The Biostat® D-DCU offers state of the art CIP solutions with integrated SIP | CIP headers and now also with an optional mobile CIP cart or the ability to connect to 3rd party CIP systems providing an electronic handshake between the control systems. Integrated CIP features allow the operator to effectively, reproducibly and automatically clean the complete system including the culture vessel, gas inlets, exhaust lines, addition lines and transfer groups.

Single-Use Sampling

The Takeone® aseptic sampling system is single-use and delivered ready to use. While traditional sampling devices require cleaning, preparation and sterilization after each use, the Takeone® single-use sampling system saves valuable time by being fully disposable.



Agitation

Bottom drive agitation is available with a double mechanical seal. The high performance servo drive motor assembly combines low shear, gentle agitation for cell cultures and high speed mixing for microbial high cell density cultivation, ensuring high oxygen transfer rates. The motor is gear-free for quiet operation – even at high speed ranges.

Supply Unit

The Supply Unit includes all process piping for temperature control as well as the exhaust and gas inlet lines. The open piping frame and ergonomic design of the skid allows for good and direct access to valves filter housings etc. All sanitary piping is sloped | self drained. The Supply Unit for culture vessels with 10 – 30 L offers a choice of lockable casters or leveling | support feet. The Supply Unit for culture vessel with 50 – 200 L is equipped with leveling | support feet. Furthermore, the Supply Units can be separated in two pieces allowing easy movement to the site of installation.

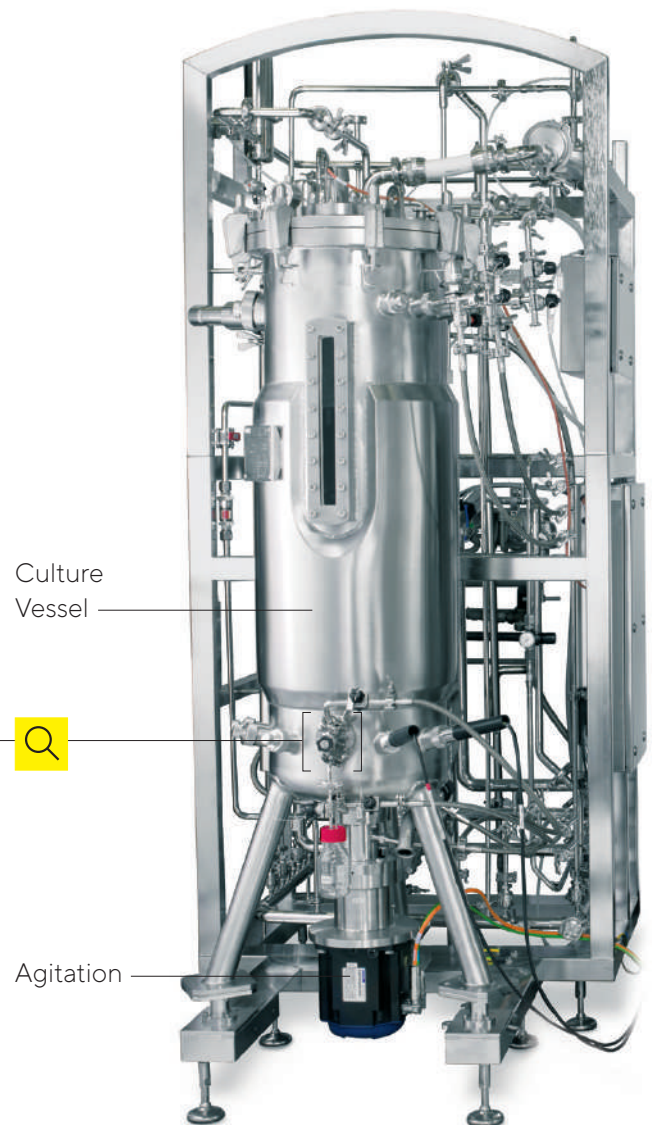



Control Tower

The Control Tower is available in Single | Twin configurations. The integrated DCU control system belongs to the most proven and advanced bioprocess controllers ever developed. Utilizing proven technology and expert engineering, our existing in-house systems bring powerful control capabilities to the sophisticated biotechnology market. Proven industrial control hardware ensures reliable system performance.

The DCU can be easily expanded and reconfigured to meet evolving research or process requirements, including scale-up from laboratory fermenters or scale-down to mimic production process conditions.

For data logging, the Digital Control Unit (DCU) includes a PC interface for SCADA software connection (for example BioPAT® MFCS). DCU OPC communication software is available for interface to other OPC compliant SCADA and DCS packages. Using a local controller for local process control in combination with a high level SCADA system ensures process control safety.



Intuitive Touchscreen

The control system presents an “intuitive-to-use”, large 19” TFT color touch screen for excellent local operation and process control for each culture vessel. Clearly designed screens provide an excellent process value overview and operation.

Gassing Systems

A variety of spargers are available for microbial and cell culture use. All systems provide individual flow rates and gas blending for each culture vessel. Gas flow rates are adjustable via precision flow meters with optional thermal mass flow controllers available for each flow path (each gas).

Dosing Pumps

Up to six integrated fast load peristaltic pumps per vessel may be chosen for addition of corrective agents, feeding, as well as culture volume control. Up to four of the six can be analog speed controlled pumps. Several ranges are available for both fixed and speed controlled pumps. Additionally, external pumps for feeding can be easily connected.

Biostat® D-DCU

Gassing Strategies

Airflow

Utilizing one flow path for air, a flow meter visually indicates and controls the sparger flow rate. An optional mass flow controller may be integrated to control and measure the flow range via manual adjustment or automatically in conjunction with the DO controller.

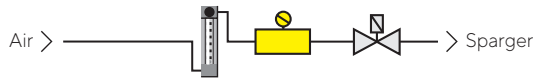

O₂-Enrichment

Utilizing two flow paths for Air and O₂ flows, the flow meters visually indicate and allow manual adjustments of the sparger flow rate. O₂ is pulsed via solenoid valve, flowing only when required to maintain the dissolved oxygen (DO) setpoint. Air is not provided at this time. A mass flow controller can be integrated to measure and control the total gas flow range via manual adjustment or automatically in conjunction with the DO controller.

O₂-Enrichment, Design up to 50 L/min

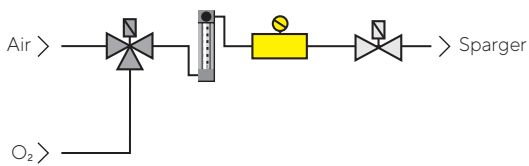

O₂-Enrichment, design up to 300 L/min

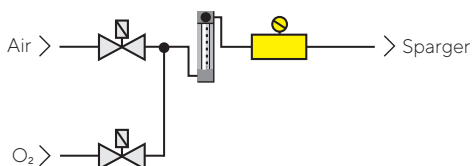

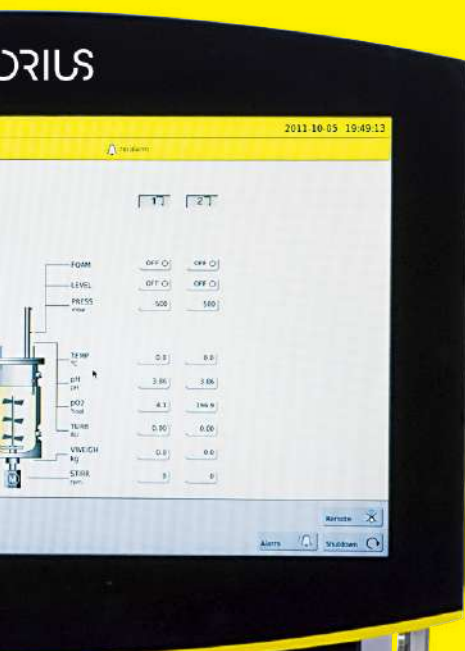

Gas Flow Ratio



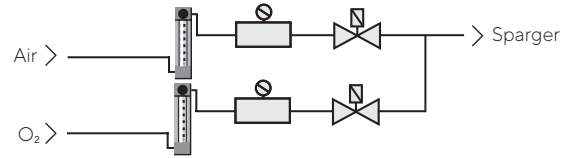



Utilizes two flow paths with mass flow control valves for Air and O₂ flow. Flow meters visually indicate the flow of Air and O₂. Both mass flow controllers can be operated manually or automatically in conjunction with the DO controller.

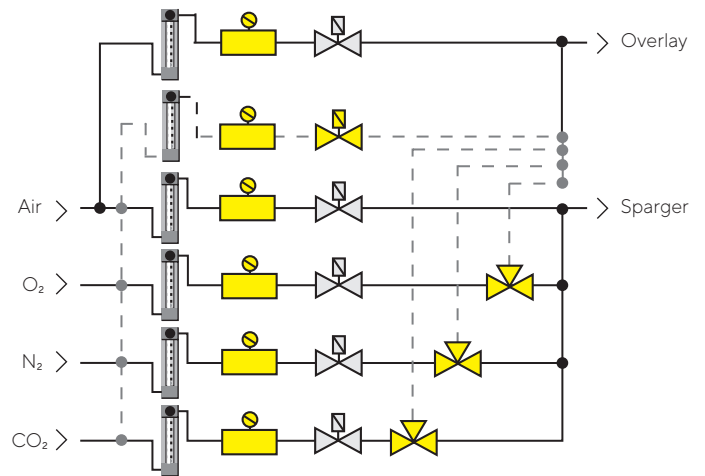

Advanced Additive Flow

Allows up to six gas flow paths. Solenoid valves select air, O₂, N₂ and CO₂ for simultaneous flow to the sparger and air to overlay. Up to six flow meters visually indicate and set the flow rate for each gas. One additional gas flow path can be added to sparger or overlay outlet. Furthermore, two 3-way solenoid valves can be installed to switch the dedicated gas from sparger to overlay (incl. soft switch). The design does support the installation of up to six mass flow controllers, which makes constant sparger gas flow control as well as constant overlay gas flow control possible.



-  Flow meter
-  Optional Gas switch
-  Dosing shut-off valve
-  Optional dosing shut-off valve
-  3-way dosing valve
-  Optional Mass Flow Controller
-  Mass Flow Controller

BioPAT® DCU – Automation Solutions for Advanced Process Control and Documentation

Our DCU (digital control unit) controller is one of the most proven, reliable and advanced bioprocess controllers ever developed. Use of a modular system design has enabled us to offer a broad range of flexible and cost-effective solutions for reusable and single-use systems from R&D to production. DCU control systems are specially tailored for fermentation, cell culture and down stream processing like cross flow filtration applications. DCU control systems allow for independent and simultaneous operation of multiple processes.

Discover the Potential of Our Standard Software...

- Superior process value overview
- Sensor calibration
- In-process recalibration
- Alarm monitoring
- Trend display
- Automatic Sterilization in Place

... and Profit From Advanced Features

- Overview of all vessels or single vessel display
- Controller status indication
- Single or group calibration
- Advanced DO controller
- Gravimetric flow control for very precise feeding
- Gravimetric harvest control
- Constant total gas flow control
- Automatic Cleaning in Place

Synchronized PAT Solutions

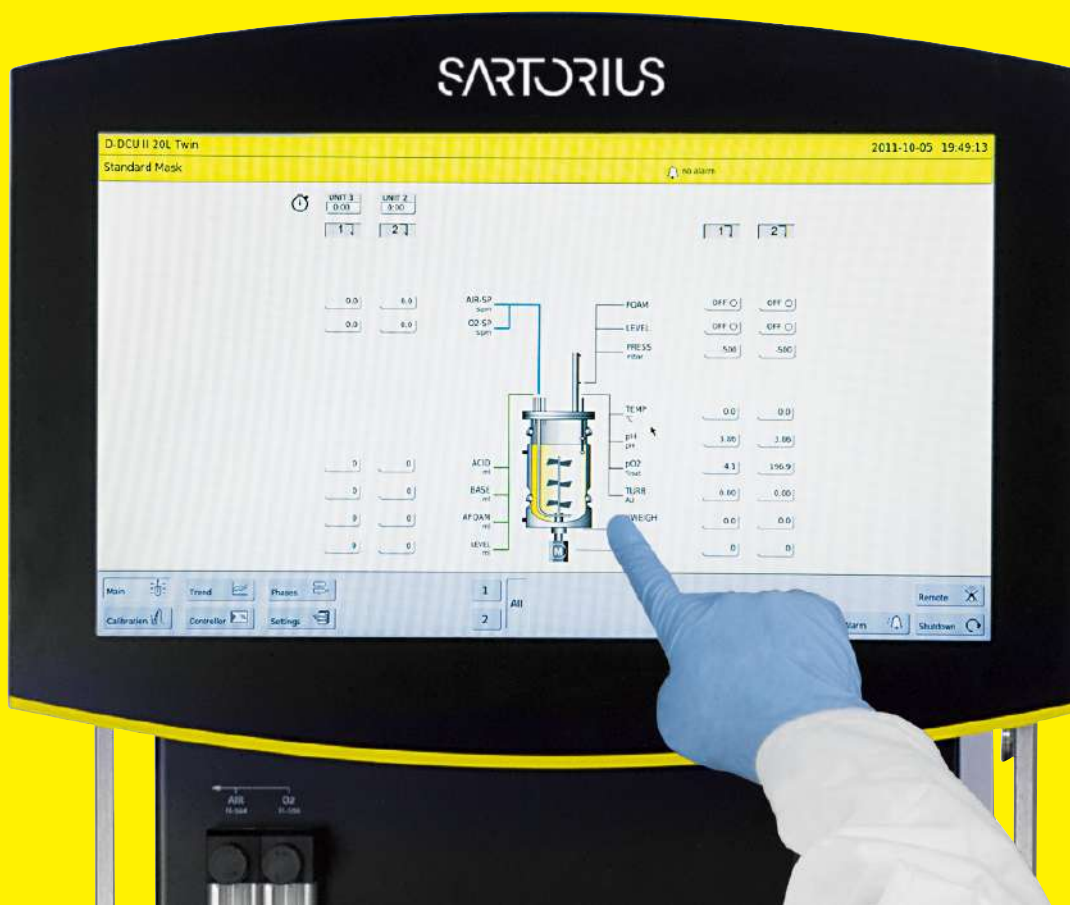

BioPAT® MFCS – The Bioprocess SCADA System

BioPAT® MFCS is our SCADA software for supervisory bioprocess control and data acquisition. Provides GMP compliant documentation of your valuable process data and ensures reliable process control in combination with the advanced Biostat® D-DCU for local process control. Supplied with every Biostat® D-DCU package, the new BioPAT® MFCS is ideal for efficient data acquisition and trend monitoring.

The Optional, Advanced Version of BioPAT® MFCS Includes Modules Such As:

- Multi-user network access for up to 16 process units
- Automation with recipes according to ANSI | ISA 88.01
- 21 CFR, Part 11 compatibility
- Multivariate Data Analysis modules



Learn more about the new BioPAT® MFCS:
www.sartorius-stedim.com/biopatmfcs

BioPAT® SIMCA-Online for Continuous Real-Time Quality Control

Continuous real-time quality control and assurance is highly desired in biopharmaceutical manufacturing. Unique on the market and developed according to GAMP 5, BioPAT® SIMCA-online is your software solution for real-time multivariate statistical process monitoring and control. The software permits early detection of process deviations. It provides user guidance to simplify root-cause analysis by displaying easy-to-understand graphics.

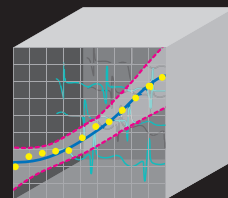

MVDA

Online Multivariate Data Analysis

Biostat® D-DCU MO

Package Overview: O₂-Enrichment

Available Volumes	10 L	20 L	30 L	50 L	100 L	200 L
H:D ratio	3:1					
Voltage	208 or 400 VAC					
Control Unit	Twin configuration optional					
Digital controller, color display with touch screen	■					
Control capabilities						
Temperature, pH, DO (Multi stage cascade), Stirrer speed	■					
Substrate A and Substrate B	■					
Foam via conductive sensor	■					
High foam alarm	■					
Automatic full vessel sterilization sequence	■					
Gear and maintenance free agitation motor	■					
Gassing strategy	O ₂ -Enrichment (Airflow and Gas Flow Ratio optional)					
Flow meter	■					
Solenoid valve for oxygen enrichment	■ (Mass Flow Controller optional)					
Peristaltic pumps (integrated)	3 for Acid Base Antifoam unused pump can be configured as substrate pump (Up to 6 pumps per site)					
Supervisory Process Control Software						
BioPAT® MFCS	■					
Supply frame	Open frame design					
Temperature control system	Closed loop system with recirculation pump and heat exchanger for heating and cooling					
Piping with valves and steam traps for automatic in-situ sterilization	■					
Culture Vessel	Jacketed stainless steel vessel with vertical sight glass and bottom agitation					
Stirrer shaft with Double Mechanical Seal (DMS)	■					
Condensate pressurization of buffer system DMS steam compressed air	■ □					
6-blade disk impeller	3					
Stainless steel filter housing for air Inlet and exhaust filter incl. filter cartridges	■					
Pressure gauge -1/3 barg	■					
Aeration tube with Ring sparger	■					
Exhaust cooler	■					
4-Baffles (removable)	■					
Resterilizable sampling valve	■					
1-Channel Sacova valve for needle free additions	■					
3-Channel Sacova valve for needle free additions	■					
Lamp for vessel illumination	■					
Storage bottles	3					
Bottom harvest valve	■					

pH Electrode, cable	■
DO Electrode, cable	■
Pressure sensor, cable	■
Foam sensor, cable	■
Temperature sensor Pt 100	■
High-foam sensor with installation adaptor, cable	■
Options	
Mobile CIP unit with DCU interface	□
Culture vessel weight measurement control	□ □
Automatic vessel pressure control	□
Pressure hold test	□
Lid lifting device 10 - 20 L 30 - 200 L	- □
Dual pH measurement Dual DO measurement	□ □
Containment sampling system	□
WIT ready filter housings for Inlet and Exhaust filter	□
Exhaust heater Dual Exhaust filter line (parallel)	□ □
Temperature measurement of condensate trap	□
Cleaning in Place (CIP)	□
Resterilizable 4-valve addition array manual automatic	□ □
Automatic harvest valve	□
Transfer group	□
Speed controlled pumps for feeding	□

Broad range of accessories available. Please contact us for further details.

■ = included,

□ = option

- = unavailable

Biostat® D-DCU CC

Package Overview: Advanced Additive Flow

Available Volumes	10 L	20 L	30 L	50 L	100 L	200 L
H:D ratio	2:1					
Voltage	208 or 400 VAC					
Control Unit	Twin configuration optional					
Digital controller, color display with touch screen	■					
Control capabilities						
Temperature, pH, DO (Multi stage cascade), stirrer speed	■					
Substrate A-D	■					
Foam via conductive sensor	■					
High Foam alarm	■					
Automatic full and empty vessel sterilization sequence	■					
Gear and maintenance free agitation motor	■					
Gassing strategy	Advanced Additive Flow					
Flow meter sparger	■ for Air, O ₂ , N ₂ , CO ₂					
Flow meter overlay	■ for Air					
Automatic Gassing strategy of Air, O ₂ , N ₂ , CO ₂ for sparger	■ via solenoid valves (Mass Flow Controller optional)					
Peristaltic pumps (integrated)	2 for Base Afoam unused pump can be configured as substrate pump (Up to 6 pumps per system)					
Data acquisition and trend monitoring software						
BioPAT® MFCS	■					
Supply frame	Open frame design					
Temperature control system	Closed loop system with recirculation pump and heat exchanger for heating and cooling					
Solenoid valves and steam traps automatic in-situ sterilization	■					
Culture Vessel	Jacketed stainless steel vessel with vertical sight glass and bottom agitation					
Stirrer shaft with Double Mechanical Seal (DMS)	■					
Condensate pressurization of buffer system DMS steam compressed air	■ □					
3-blade segment impeller	2					
Stainless steel filter housing for Air Inlet (Sparger and Overlay) and Exhaust filter incl. filter cartridges	■					
Pressure gauge -1/3 barg	■					
Aeration tube with micro sparger	■					
Exhaust Cooler	■					
4-Baffles (removable)	■					
Resterilizable sampling valve	■					
1-Channel Sacova valve for needle free additions	■					
3-Channel Sacova valve for needle free additions	■					
Lamp for vessel illumination	■					
Storage bottles	2					
Bottom harvest valve	■					

pH Electrode, cable	■
DO Electrode, cable	■
Pressure sensor, cable	■
Foam sensor, cable	■
Temperature sensor Pt 100	■
High-foam sensor with installation adaptor, cable	■
Options	
Mobile CIP unit with DCU interface	□
Culture vessel weight measurement control	□ □
Automatic vessel pressure control	□
Pressure hold test	□
Lid lifting device 10 - 20 L 30 - 200 L	- □
Dual pH measurement Dual DO measurement	□ □
Containment sampling system	□
WIT ready filter housings for Inlet and Exhaust filter	□
Exhaust heater Dual Exhaust filter line (parallel)	□ □
Temperature measurement of condensate trap	□
Cleaning in Place (CIP)	□
Resterilizable 4-valve addition array manual automatic	□ □
Automatic harvest valve	□
Transfer group	□
Speed controlled pumps	□

Broad range of accessories available. Please contact us for further details.

■ = included,

□ = option

- = unavailable

Biostat® D-DCU

Technical Specification

Technical Specification	10 L	20 L	30 L	50 L	100 L	200 L		
Space requirement Single [W × H × D] inch m	58.3 × 82.7 × 43.3 1.48 × 2.1 × 1.1	58.3 × 82.7 × 44.5 1.48 × 2.1 × 1.13	58.3 × 82.7 × 45.3 1.48 × 2.1 × 1.15	76.8 × 92.9 × 61.8 1.95 × 2.36 × 1.57	76.8 × 100.8 × 61.8 1.95 × 2.56 × 1.57	76.8 × 120.1 × 70.9 1.95 × 3.05 × 1.8		
Space requirement Twin [W × H × D] inch m	84.6 × 82.7 × 43.3 2.15 × 2.1 × 1.1	84.6 × 82.7 × 44.5 2.15 × 2.1 × 1.13	84.6 × 82.7 × 45.3 2.15 × 2.1 × 1.15	122 × 92.9 × 61.8 3.1 × 2.36 × 1.57	122 × 100.8 × 61.8 3.1 × 2.56 × 1.57	122 × 120.1 × 70.9 3.1 × 3.05 × 1.8		
Required wall opening dimensions [W × H] inch m	31.9 × 78.8 0.81 × 2	31.9 × 78.8 0.81 × 2	31.9 × 78.8 0.81 × 2	41.8 × 67 1.06 × 1.7	41.8 × 67 1.06 × 1.7	41.8 × 67 1.06 × 1.7		
Culture vessel weight (approx.) [kg]	80	100	120	300	450	600		
Supply Unit weight (approx.) [kg]	170	170	170	320	320	320		
Control Tower weight (approx.) [kg] Single Twin	160 205							
Ambient temperature relative humidity (non-condensating)	5 – 40°C 85%							
Utilities Requirements	Conditions	Max. Flow	Vessel Size					
			10 L	20 L	30 L	50 L	100 L	200 L
Process Air MO CC Sparger Overlay	4 barg 58 psig, controlled, Class 2 (ISO 8573-1)	[L/min]	15 1/10	30 3/20	45 3/30	75 5/60	150 10/100	300 20/200
O ₂ MO Sparger CC Sparger Overlay	4 barg 58 psig, controlled, prefiltered	[L/min]	15 1/5	30 3/10	45 3/15	75 5/25	150 10/50	300 20/100
CO ₂ MO Sparger CC Sparger Overlay	4 barg 58 psig, controlled, prefiltered	[L/min]	N A 1/5	N A 3/10	N A 3/15	N A 5/25	N A 10/50	N A 20/100
N ₂ MO Sparger CC Sparger Overlay	4 barg 58 psig, controlled, prefiltered	[L/min]	N A 1/5	N A 3/10	N A 3/15	N A 5/25	N A 10/50	N A 20/100
Utility steam	4 barg 58 psig, controlled, prefiltered	[kg/h]	15	15	15	50	90	160
Clean steam	1.5 barg 21.8 psig, controlled, prefiltered	[kg/h]	5	5	5	8	10	26
Cooling water	4 barg 58 psig, controlled (15°C) prefiltered	[L/min]	5	5	5	25	25	50
Cooling water return	Atmospheric pressure to 1.5 barg 21.8 psig	[L/min]	5	5	5	25	35	50
CIP, cleaning and rinsing fluid	1.5 barg 21.8 psig, controlled	[L/min]	on request			33	43	70
Condensate	Atmospheric pressure (max. Temp. 98°C)							
Instrument air	6 barg 87 psig, controlled							
Power supply (TNS net): 5 wire: 3 × phase, 1 × ground, 1 × neutral	208 VAC/24A (FI switch intern 300mA) or 400 VAC/20A (FI switch intern 300mA)							
Power supply for electrical heater (TNS net): 5 wire: 3 × phase, 1 × ground, 1 × neutral	208 VAC/16A or 400 VAC/10A							

MO: Microbial Application; CC: Cell Culture Application
Specifications are subject to change without notice

Control Tower	Integrated DCU-Controller, Gassing System and Pumps Single or Twin configuration						
Controller	Industrial PC (Siemens)						
Housing material	Stainless steel AISI 304						
Display Operation	Touch Panel 19" Touch screen						
Host communication	Industrial Ethernet						
External connections	Expandable process I/O						
Balance connection	3 per vessel; expandable of up to 6 per vessel						
External Inputs Off gas analyzer input	2 per vessel; Analog in (0-10 V) 2 per vessel Analog in (4-20 mA)						
External feed pumps	up to 4 per vessel; 2 per vessel; Analog out (0-10 V)						
Gassing System	Up to 6 integrated Mass Flow Controllers and Flowmeter						
MO application	Air aeration, O ₂ -Enrichment or Gas Flow Ratio; Max. total flow rate: 1.5 vvm						
CC application	Advanced Additive Flow; Max. total flow rate: Overlay 1 vvm Sparger 0.1 vvm						
Flow meter	Air calibrated @ 4 barg 20°C scale length 120 mm						
Flow range	0.12-1.06 L/min up to 70-330 L/min						
Accuracy	±4% FS						
Thermal Mass Flow Controller	Air N ₂ , O ₂ or CO ₂ calibrated						
Flow range	0.02-1.0 sLpm up to 6-300 sLpm						
Accuracy	±1% FS						
Integrated pumps	Up to 6 per vessel (2 × digital + 2 × digital speed controlled + 2 × speed controlled)						
Pump head For tubings with 1.6 mm 1/16" wall thickness	Watson Marlow 114 For tubings with bore 0.5-4.8 [mm] 1/50-3/16 ["]			Watson Marlow 314 For tubings with bore 0.5-8.0 [mm] 1/50-5/16 ["]			
Rotation speed [rpm]	5	44	up to 200	6	60	up to 200	
Flow range [mL/min]	Bore 0.5 mm 1/50" 4.8 mm 3/16" 8.0 mm 5/16"	0.1 0.09-4.3 N/A	0.02-0.9 0.75-37.4 N/A	0.4-4 17-170 N/A	0.0-0.18 2.3-11.4 0.48-24	0.04-1.8 2.3-11.4 4.8-240	0.6-6 38-380 80-800
Supply Unit	Piping Skid in open frame design						
Material Surface finish (product wetted parts)	Stainless steel AISI 316 L MO: Ra < 0.8 µm (31.5 Ra or better) CC: Ra < 0.4 µm (15.7 Ra or better)						
Temperature control system - steam version	Closed loop thermostat system with recirculation pump, heat exchanger for cooling and heating or and electrical heater						
Temperature control (operation sterilization):	8°C above cooling water to 90°C up to 130°C						
Heat exchanger (cooling heating - steam version)	Stainless steel, copper soldered, optional stainless steel welded version available upon request						
Electrical heater (optional)	6 kW (10-30 L: complete electrical heated; 50-200 L: auxiliary electrical heater only)						

Culture vessel	10 L		20 L		30 L		50 L		100 L		200 L	
H:D ratio	2:1	3:1	2:1	3:1	2:1	3:1	2:1	3:1	2:1	3:1	2:1	3:1
Total volume	14 L	15 L	29 L	31 L	42 L	41 L	74 L	77 L	152 L	152 L	313 L	323 L
Working volume	10 L	10 L	20 L	20 L	30 L	30 L	50 L	50 L	100 L	100 L	200 L	200 L
Minimal working volume	3.5 L	2.5 L	5.5 L	3.5 L	6.4 L	5.4 L	13 L	13L	24 L	24 L	47 L	41 L
Jacketed cylindrical part Jacketed bottom	yes no	yes no	yes no	yes no	yes no	yes no	yes no	yes no	yes yes	yes no	yes yes	yes no
Weight lid with blind plugs [kg]	12	11	16	14	18	16	34	22	45	35	95	68
Agitation speed ranges for MO (max. impeller tip speed \geq 5 m/s)	20–1500	20–1500	20–1200	20–1200	20–1100	20–1100	20–900	20–900	20–700	20–700	20–570	20–570
Motorpower torque [kW Nm]	2.3 5	2.3 5	3.1 9.4	3.1 9.4	3.1 9.4	3.1 9.4	4.2 16.2	4.2 16.2	4.9 26.7	4.9 26.7	6.6 48.2	6.6 48.2
Agitation speed ranges for CC (max. impeller tip speed \geq 2 m/s)	350	N A	300	N A	260	N A	220	N A	180	N A	130	N A
Motorpower torque [kW Nm]	2.3 5	N A	2.3 5	N A	2.3 5	N A	3.1 9.4	N A	4.2 16.2	N A	4.2 16.2	N A
Impeller to vessel diameter [Rushton impeller]	0.4	0.4	0.4	0.4	0.4	0.4	0.4	0.4	0.4	0.4	0.4	0.4
Impeller to vessel diameter [3-blade segment impeller]	0.5	N A	0.5	N A	0.5	N A	0.5	N A	0.5	N A	0.5	N A
Lid ports	1 × sight glass for illumination 1 × port for exhaust 9 × 19 mm port						1 × sight glass for illumination 1 × spare port DN 50 1 × port for CIP – connection 1 × port for exhaust 8 × 19 mm port 3 × lifting eye					
Upper side wall	4 × 25 mm port 1 × sparger aeration 1 × overlay aeration bypass sparger 1 × port for rupture disc safety valve 1 × rectangular sight glass						3 × 25 mm port 1 × sparger aeration 1 × overlay aeration spare 1 × port for rupture disc 1 × spare DN50 1 × rectangular sight glass					
Lower side wall	5 × 25 mm port 1 × sanitary TC port 1 × port for temperature sensor						5 × 25 mm port 1 × sanitary TC port 1 × port for temperature sensor					
Bottom	1 × flange for agitator 1 × harvest drain valve						1 × flange for agitator 1 × harvest drain valve					
Jacket	1 × fluid in 1 × fluid out						1 × fluid in 1 × fluid out					
Vessel design	Jacketed stainless steel vessel with torospherical bottom and vertical sight glass bottom agitation system											
Material (product wetted parts)	Stainless steel AISI 316 L Borosilicat glass EPDM (FDA approved)											
Surface finish product wetted	2:1 Vessel Ra \leq 0.4 μ m (15.7 Ra or better), electropolished 3:1 vessel: Ra \leq 0.8 μ m (31.5 Ra or better), electropolished											
Pressure design criteria vessel jacket	-1/3 barg @ 150°C -1/4 barg @ 150°C											

Sensors measurement ranges resolution	
Dissolved oxygen	Polarographic or optical 0 - 100% 1% 0.1%
pH	Gel filled 2 - 12 0.01 pH
Foam Level High Foam	Conductive probe, stainless steel ceramic isolated
Temperature sensor Vessel Jacket	Pt100 0 - 150 °C 0.1 C
Redox	Gel filled -1000 - 1000 mV 1 mV
Pressure	Piezoresistive sensor -0.5 - 2 [barg] 1 mbar
Turbidity	Single Channel NIR Absorption Probe, 0 - 6 AU 0.01 AU
Regulatory compliance	CE UL CSA (EN61010, UL61010); Culture vessel: ASME or PED or China pressure vessel regulation

Germany

Sartorius Stedim Biotech GmbH
August-Spindler-Strasse 11
37079 Goettingen
Phone +49 551 308 0

USA

Sartorius Stedim North America Inc.
565 Johnson Avenue
Bohemia, NY 11716
Toll-Free +1 800 368 7178

 For further contacts, visit
www.sartorius.com