

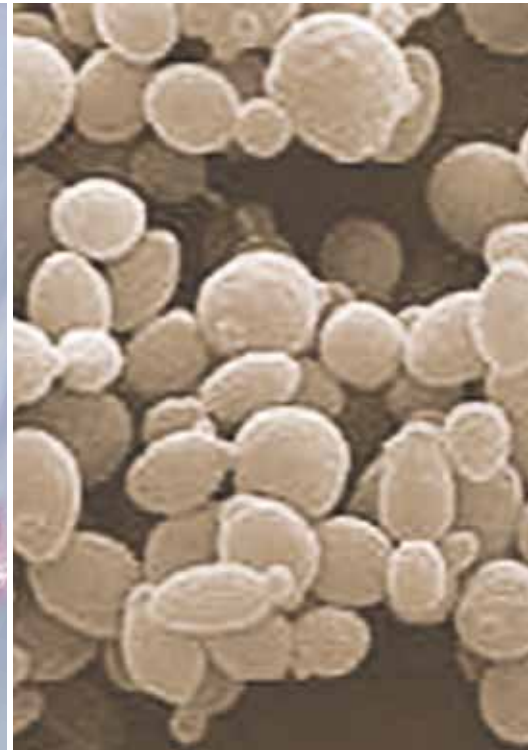

sartorius stedim  
biotech

## Microbiology and Wine Preventive care and monitoring in the wine industry



turning science **into solutions**

# Contents

1. Project Objective	4
2. Which Microbes are found in the Winery?	5
3. Testing Methods	7
4. Materials for Routine Microbiological Testing	16
5. Flow Chart of Winemaking and Checklists for Testing	20
6. Cleaning and Checklists for Cleaning	26
7. Plant Hygiene Training	31
8. Risk Assessment and HACCP	36

## 1. Project Objective

This brochure is intended to help winemakers and wineries test their products and the hygiene of their facilities and to assess these under microbiological aspects. The brochure begins with a description of the particular microbes most frequently encountered in wineries and it outlines the properties of the must, wine, or various additives that influence the growth of microorganisms. The various wine diseases of microbial origin are not dealt with in this brochure, as there is considerable literature available on this subject.

The third chapter addresses test methods that should be used in the various areas and for different samples. Following this chapter is a description of the equipment and culture media that can be used for this purpose. Further methods for microbial differentiation and colony identification are also discussed.

A flow chart illustrates the various stages of the winemaking process, ranging from delivery of grapes to bottling, and a risk assessment is carried out for each stage.

Finally, based on this flow chart, a test plan is provided that can be used for routine testing in wineries. The test plan includes a stage check to be used if microbiological contamination occurs in the final product. Methods, culture media and assessment criteria are described for both this situation and for routine tests.

Chapter six contains important instructions on the sanitation of systems used in routine winemaking, and chapter seven provides information on training in hygienic procedures.

Dr. Elke Just and Hildegard Regnery

## 2. Which Microbes are Found in the Winery?

The particular microorganisms present in a product or production area will depend on the relevant ambient conditions in the product or production area and on the specific requirements that various microorganisms have in order to grow.

Certain strains of fermentation yeast are mandatory for the fermentation process itself. Likewise, lactic acid bacteria are also often used systematically for this purpose. Within this context, both groups should not be considered as spoilage organisms. However, these microorganisms must be removed or deactivated at a later stage, once the finished wine has been bottled, so that they do not alter the wine through renewed growth. All microorganisms can therefore be considered as undesirable in filled wine bottles and are regarded as spoilage organisms.

Grape must is characterized by a low pH, a good range of nutrients such as sugar, protein and trace elements, and aerobic conditions, allowing the growth of acetic acid bacteria, as well as yeasts, molds, and (in particular) those lactobacilli that develop in the presence of oxygen. In contrast, anaerobic conditions and the presence of alcohol are typical for bottled wine. Both factors limit mold growth, meaning that this type of microorganism is considered a spoilage organism for grapes and must, but not for wine. The same applies for acetic acid bacteria whose growth is strictly aerobic. However, the anaerobic conditions in wine promote the growth of lactic acid bacteria, making these significant spoilage bacteria in bottled wine. Yeasts can endure both alcohol and anaerobic conditions and for this reason they are generally considered as the major spoilage organisms in bottled wine.

Trivial microbes that enter through water, air or soil do not spoil the product as they cannot proliferate under the conditions that prevail in wine. However, if they are present in large numbers, they may contribute to the degradation of  $SO_2$  used as a preservative. Contamination with yeast can be either more or less critical depending on the type and strain of the yeast encountered. While strongly fermenting yeasts will encourage wine to ferment quickly, (frequently resulting in bottle explosion), weakly fermenting yeasts can cause cloudiness.

In either case, positive microbiological findings will usually result in undesirable changes to the taste, of the wine.

Here is a brief overview of the wine-spoilage microbes most commonly found:

### Bacteria

#### Trivial bacteria that are not spoilage organisms (total CFU\* count)

These microbes do not affect the taste or smell of the wine.

Nevertheless, they can contribute to the degradation of free  $SO_2$ , which may affect the stability of the wine if they are present in large numbers. These microbes include:

- Water bacteria that are transmitted via water used for washing and rinsing
- Hygiene-related bacteria that provide an insight into the hygienic environment
- Airborne bacteria that spread as the result of their ability to survive.

#### Product-spoilage bacteria

Product-spoilage bacteria originate from the leaves of the grapevine and the grapes themselves. Lack of hygiene may result in them being carried into the finished product. The subsequent effect on the wine is manifested in various wine diseases, a topic which is not discussed in detail here. In principle, it can be said that lactic acid bacteria cause cloudiness and have a negative effect on the taste of the wine if they begin to grow in the filled bottles. The taste of lactic or acetic acid is typical, but other disruptive taste notes may occur. They can cause acid degradation and give the wine a

slimy, oily consistency. A fact is that acetic acid bacteria cause the wine to taste off. Spore-forming bacteria are sometimes found in wine. However, these microorganisms do not grow at the pH that is normally characteristic for wine and thus they often occur only as secondary spoilage organisms after wine has already been subjected to extensive acid degradation.

Lactic acid bacteria: homofermentative and heterofermentative rod-shaped lactic acid bacteria:  
Lactobacillus brevis  
Lactobacillus buchneri  
Lactobacillus casei  
Lactobacillus fermentum  
Lactobacillus fructivorans  
Lactobacillus lindneri  
Lactobacillus plantarum

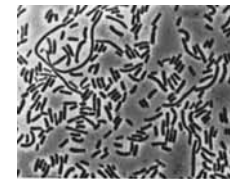

Lactobacillus brevis

Lactic acid cocci:  
Oenococcus oeni  
Pediococcus inopinatus  
Pediococcus damnosus  
Pediococcus pentosaceus

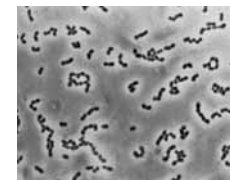

Leuconostoc mesenteroides

Acetic-acid bacteria:  
Acetobacter aceti  
Acetobacter pasteurianus  
Gluconobacter oxydans

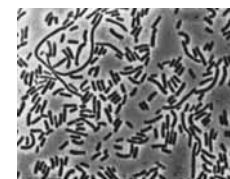

Acetobacter aceti

## Yeasts

In principle, yeasts are undesirable in the finished product, even if they are not of the strongly fermenting type that represent a direct risk of secondary fermentation.

Yeasts can survive in spore form in soil, but they usually originate from the surface of the grapes, on which up to 100,000 yeasts per grape can be found. They find natural access to the inside of the grape through the stomata. Yeasts are also able to penetrate if the grapes are damaged by insect bites. Weakly fermenting yeasts are usually predominant and only at a later stage are they outnumbered by more strongly fermenting species. They can impart an off-odor or off-taste to the wine and can decompose the alcohol. Those yeasts that need oxygen (aerobic yeast) are a problem in grape must, but not in wine itself as the growth conditions are unfavourable.

Yeasts required for fermentation:  
*Saccharomyces cerevisiae*, various subspecies and strains

Wild yeasts:

Strongly fermenting yeasts:

*Saccharomyces ludwigii*  
*Schizosaccharomyces pombe*  
*Zygosaccharomyces baillii*  
*Zygosaccharomyces florentinus*

Fermenting yeasts:

*Kloeckera apiculata*  
*Pichia anomala*  
*Saccharomyces kluyveri*  
*Torulasporea delbrueckii*  
*Zygosaccharomyces rouxii*  
*Zygosaccharomyces microellipsoides*

Weakly fermenting yeasts:

*Brettanomyces anomalus*  
*Brettanomyces bruxellensis*  
*Candida*  
*Dekkera*  
*Hansenula*  
*Pichia anomala*

Oxygen-requiring yeasts:

*Candida*  
*Cryptococcus albidus*  
*Debaromyces hansenii*  
*Pichia membranefaciens*  
*Rhodotorula glutinis*

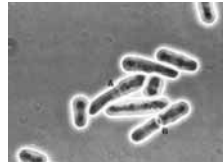

*Schizosaccharomyces pombe*

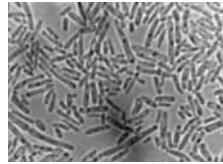

*Brettanomyces naardenensis*

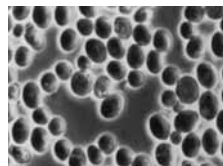

*Zygosaccharomyces rouxii*

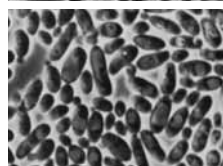

*Pichia membranefaciens*

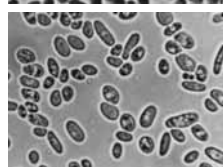

*Saccharomyces cerevisiae*



*Rhodotorula glutinis*

## Molds

Molds are normally not a problem in wine, but if the grapes are bruised beforehand, molds can cause an off-taste.

*Aspergillus*  
*Aureobasidium pullans*  
*Botrytis cinerea*  
*Mucor*  
*Penicillium*



*Aspergillus*



*Penicillium*

Microbes that grow in grape must are different from those that propagate in fermented wine, and thus there is a shift in the microbial flora from the grape to the bottled wine.

At first, wild yeasts predominate. These cannot cause strong fermentation, but they do reduce the oxygen content in grape must as they grow, thus paving the way for fermenting yeasts to take over.

Acetic acid bacteria only grow in the presence of oxygen and usually decrease in number as oxygen levels fall. Even if they do not die off entirely, they are no longer able to grow and multiply. The same also applies to molds. However, both groups can cause a strong off-taste in grape must that cannot be removed from the wine later.

Users frequently ask how many bacteria can be tolerated in filled bottles without causing problems. Unfortunately, you never get a conclusive reply. We cannot answer this question, either. It depends too much on the individual characteristics of the product and production plant that generalizations would be of little help. A few yeasts per bottle will not harm dry, well-fermented wine varieties. This is different for wines with a high residual sugar content: even a few yeast cells can lead to secondary fermentation. In addition to residual sugar content, free  $\text{SO}_2$  content also plays a role. And, of course, it depends on what type of yeast is present. Is it a fermenting yeast or only an aerobic yeast? The latter does not pose an acute threat to the product, but the former does. The same applies to bacteria content. Many wineries only check for yeast content and ignore the presence of bacteria. However, this can be risky, as many wine diseases are caused by bacteria. In addition to simply detecting the presence of bacteria, a general identification is needed to check the potential risk their presence actually poses to the product.

# 3. Testing Methods

In a winery, the ultimate goal of microbiological monitoring is to ensure the safety of the end product, in other words, of the bottled wine itself and of its various stages during processing, i.e. from grape must through cellaring up to the final filtration. This process involves working with liquid samples for which the membrane filter method is primarily used.

In addition, the production systems also have to be monitored as the majority of all microbial contamination originates in the filling or corking machines. Here we are no longer dealing with liquid samples, but with the monitoring of surface contamination, for which a different set of tests is required. Determining each surface's colony count is a very important part of hygiene in wineries and indispensable at numerous stations.

The risk of airborne microbial contamination is higher or lower depending on the winery's spatial layout. Airborne microbial contamination can, however, never be ruled out, which is why it is becoming more and more common to test the air for microorganisms.

Compressed air poses a relatively low risk. However, a test method is available, should tests become necessary.

## 3.1. Liquid Sample Testing

### 3.1.1. The Membrane Filter Method

The purpose of the membrane filter method is to isolate a small number of microorganisms from as large a sample as possible and to demonstrate their presence as colonies by subsequent incubation on a culture medium. This is the only way a trace infection can be detected at an early stage. For this purpose, a filter unit consisting of a filter holder, filter funnel and suction flask (1) as well as vacuum are used. In the filter unit, a membrane filter is placed on the filter holder (2), the sample is poured into the filter funnel (3) and transferred into the suction flask by applying a vacuum. The microorganisms are retained on the filter surface and concentrated from the filtered volume. The filter unit is rinsed



| 1



| 2



| 3

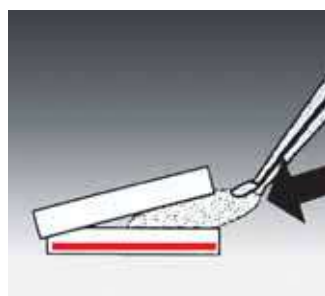

| 4

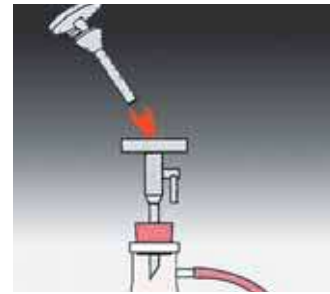

| 5



| 6



| 7

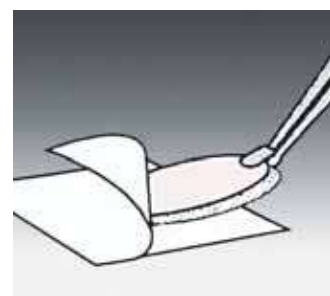

| 8



| 9

with a few milliliters of sterile water to remove any residues from the sample. Then, the membrane filter is placed on a suitable culture medium (4) where it is incubated for the prescribed time. Once this process has been completed, the number of colonies is counted. This count is equivalent to the concentrated number of microorganisms present in the sample. The filter unit must always be disinfected between two samples, which is routinely done by flaming the filter support (5), the bottom of the filter funnel (6) and the inside of the filter funnel (7), or by burning off alcohol

in the filter funnel. The membrane filters are positioned and removed using forceps (8), which must also be sterilized by flaming (9) after each use.



# The correct use of Nutrient Pad Sets

## How to prepare the filtration equipment

**1** Before starting with the tests remove everything that is not essentially needed for this work.

**2** Carefully clean and disinfect your working area.  
For simple microbiological tests a laminar flow box is not needed.  
When used unprofessionally, a laminar flow box increases the risk of secondary contamination instead of protecting from it.

**3** A good protection against airborne contamination, however, is to work close to the flame of a Bunsen burner. Instruments like forceps should be placed into a glass with alcohol.

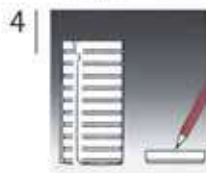

Label the required amount of Petri dishes.



Wet the pads with 3.5 ml of sterile, deionized or distilled water.  
Use a sterile pipette or a dosing syringe with a sterilizing filter. Open the lid of the Petri dish only slightly to avoid airborne contamination.

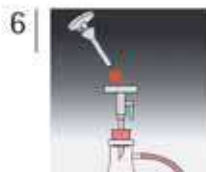

Open the vacuum valve and carefully flame the filter support for ~10 sec. Close the vacuum valve again.



Take the funnel at both sides of the clamp and flame it from its lower side. Then place it on the filter support.



Open the vacuum valve again and flame the inside of the funnel.  
Close the valve again.  
To cool it off faster, rinse with a few ml of sterile water.



The forceps should always be stored in a small glass with alcohol. Take it out of it and flame it. Let it cool off for a few seconds before use.

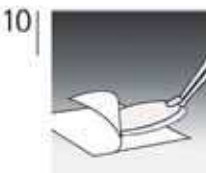

Open the cover of the sterile single-packed filter without touching the filter with your fingers. Take it out together with the yellow protective disc with the sterilized forceps.

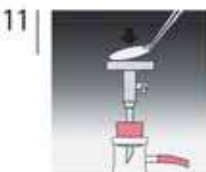

Place both together on the filter support. The yellow protective disc will coil up by the water residues of the frit.



Thus it can easily be removed and discarded.



Place the funnel on the filter support and close it with the clamp.  
For longer filtration cover the funnel with the lid.

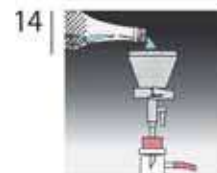

Open the valve and filter the sample. Rinse with a few ml of sterile water to remove all product residues or inhibitors that might be contained in the sample. Close the valve again.



Remove the funnel and take the filter with the sterile forceps.



Place the filter on the Nutrient Pad, avoid to entrap air bubbles under the filter.  
Open the lid of the Petri dish only slightly to avoid airborne contamination.



Place the Petri dish into the incubator, lid above.  
Incubate strictly according to the recommendations.  
Evaluate immediately after the end of the incubation time.

For reasons of convenience, individually sterile-packaged membrane filters are used. They do not need to be sterilized, and are immediately ready to use. Disposable filter units made of plastic are pre-sterilized and do not have to be disinfected as is the case with stainless steel filter holders.

The membrane filter should be made of cellulose nitrate because this material has the best growth properties for microorganisms. The pore size of the filter is selected depending on the objective of testing. To detect bacteria, a pore size of 0.45  $\mu\text{m}$  is commonly used. To detect the much larger yeasts and molds, a membrane filter with a pore size of 0.65  $\mu\text{m}$  or 0.8  $\mu\text{m}$  is selected. In some cases, 1.2  $\mu\text{m}$  is sufficient. These coarser membranes have a faster flow rate, which saves time during filtration. The risk of microorganisms squeezing through the membrane due to coarser pore size and escaping detection is absolutely non-existent for yeasts and molds.

In cases where the sample volume is too small for filtration, as is the case for rinsing liquid, a few drops of the sample can be dropped directly onto the agar plate. However, it is not possible to remove inhibitors. Should this be necessary, which certainly can be the case after disinfection, first fill a few milliliters of sterile water into the filter funnel and then add a few drops of sample. This way even very small volumes can be tested with the membrane filter method, whereby inhibitors, such as disinfectants, are rinsed out.

### 3.1.2. Bottle Rinsing Method

The purpose of this method is to submit the cleaned bottles to microbiological testing. This is achieved by filling the cleaned bottles with approximately 50 ml of sterile water and by shaking them vigorously to flush the bacteria from the walls of the bottle so that they can be detected by subsequent membrane filtration of the rinse water.

### 3.1.3. The Mayer-Vetsch Method

This method is very easy to carry out and does not require any equipment whatsoever, however it only detects very high colony counts of some hundred per bottle.

Test tubes containing 20 ml of a special agar are used, the agar should not be solid and still allow stirring. If need be, the agar can be prepared by liquefying a solid agar medium and diluting it with sterile water. With a pipette, 2 ml of sample are stirred carefully into the medium avoiding air bubbles.

During the subsequent incubation, the transferred microorganisms will grow into colonies that become visible in the agar. Because the sample volume is limited to approximately 2 ml, it is not possible to detect trace infections with just a few bacteria per bottle. Actually, a higher degree of contamination has to be present before bacteria can be detected.

### 3.1.4. Liquid Enrichment

This method is also easy to use, but because of its small sample volume it is not suitable for the detection of trace infections. Ten milliliters of the test sample are pipetted into sterile test-tubes, each of which contains 10 ml of grape must. The sample should best be taken from the bottom of the bottle in order to capture any sedimentary bacteria. Both yeasts and bacteria grow in the grape must and can be identified through cloudiness. In contrast to the previously described methods, this method enables only a qualitative, but not a quantitative analysis to be made (for example: 10 ml without findings).

If wine mixed drinks that contain pulp or other cloudy substances have to be tested, the membrane filter method often cannot be used. The reason being that it takes no more than a few milliliters of sample for the particles to block the membrane filter. In this case, 100 to 200 ml of the product must be mixed with nutrient broth (20 to 200 ml depending on the solution's concentration). After incubation, an inoculating loop is used to streak a drop of the enriched liquid on the solid culture medium (or on the moist nutrient pad on which a dry sterile filter has been laid). Two days are usually long enough to determine whether the enrichment resulted in microbial growth, which will be manifested as colonies on the culture medium, or whether the sample was sterile.

## 3.2. Surface Testing

### 3.2.1. The Contact Plate Method



This method is used to test the bacterial contamination of relatively smooth surfaces.

Contact can be made directly with an agar plate (RODAC plate). This method uses a special agar plate that is filled to the upper rim that makes contact when pressed on a surface. The bacteria stick to the agar and can be counted as colonies after incubation.

A RODAC plate's lifespan is usually quite short because the moisture in the agar evaporates and the surface sinks, making contact between the surface and the agar impossible. This is why membrane filters can also be used in such cases to collect bacteria, not through filtration, but by the contact between the membrane and the surface to be tested. Open a corner of the membrane packaging. Use flamed, sterile forceps to remove the protective paper disk without removing the membrane. Place the membrane and the carrier paper face-up (gridded side) on to the surface to be tested. Rub the back of the carrier paper to charge the membrane with static electricity. The electrical charge ensures that the microorganisms on the tested surface stick to the membrane. Then, remove the membrane and the carrier paper from the surface. Do this carefully so that the back of the membrane filter remains sterile. Remove the membrane, and, depending on

the objective, incubate it on the appropriate culture medium. When testing moist surfaces, the back of the carrier paper does not have to be rubbed because the microorganisms and the moisture are drawn from the pad and adhere to the upper side of the membrane filter. Attraction by electrostatic charge is neither possible nor required for moist surfaces.

### 3.2.2. The Swab Test Method

Swab tests are suitable for the semi-quantitative analysis of the colony count in areas that are difficult to reach and cannot be tested with the contact plate method. Moist cotton swabs are used to test dry surfaces. Dry swabs are used to test moist surfaces.



The cotton swabs must be sterile and can be moistened with sterile physiological saline solution.

In order to obtain approximated quantitative evidence, the streaked area should at least be roughly determined. To collect the microorganisms, the surface to be tested is wiped with the cotton swab. The swab can then be directly streaked onto the agar plate, although there is a risk of losing a large part of the microorganisms because they stick to the cotton. A quantitatively better result can be achieved by rinsing the cotton swabs in sterile water and testing the water using the membrane filter

method. For qualitative analysis, which is often sufficient, the swab can be simply incubated in a broth. This provides the best recovery, but does not allow quantitative results to be obtained.

### 3.3. Testing Methods for Airborne Microorganisms

#### 3.3.1. The Sedimentation Method

For this method, open petri dishes with culture medium are placed in exposed areas of the production facilities (filling area) for a defined time and are then incubated. The disadvantage of this method is the low volume of air that can be sampled depending on the movement of the air. It is recommended to keep the Petri dishes open for approximately 20 to 30 minutes depending on the expected colony count. This method does not provide a quantitative result per defined volume of air, but allows qualitative, comparative evidence to be obtained for different locations or times of day.



This method can also be carried out by vertically attaching petri dishes with culture medium in the production facilities (mainly to the filling block, the filter, the labeling machine etc.) and leaving them there for approximately 2 hours before removing them and incubating them for 2 to 3 days.

#### 3.3.2. The Gelatin Membrane Filter Method

This method is used to quantitatively establish the colony count per volume unit ( $m^3$ ) of air. A Rotameter device is used to sample in the air (vacuum cleaner principle). The air flows through a sterile gelatin membrane filter, which is placed on a filter support and attached onto the unit. The sampling time and the air throughput can be adjusted. With the direct gelatin membrane filter method, the gelatin membrane filter is placed directly onto standard agar and left to incubate for 3 days (ideal time).

The collected microorganisms can be distributed among several culture media by dissolving the gelatin filter in warm sterile water, filtering the solution in portions through several membrane filters, and incubating these membranes on different media.





### 3.4. Which test methods can be used where?

Liquid enrichment, swab test, rinsing, contact, membrane filter method, etc.

- 1. Membrane filtration** of the sample and incubation of the filter on nutrient pad sets or on agar plates | all sites on all types of filter systems, inlet and outlet, filled bottles, rinse water, splash water, etc.
- 2. Contact plate method and swab test** hygiene tests throughout the winery including all vessels, vats, conveyor belts, equipment and machines used to process grapes, as well as pipes, hoses, tanks or barrels, filling stations, and corking machines.
- 3. Rinsing, filtration of the solution** empty bottles, connectors, corks or caps.
- 4. Liquid enrichment in grape juice** connectors, seals
- 5. Pour residue out of the bottle** directly onto the agar culture medium or onto the moistened nutrient pad set, with filter | for bottle rinser
- 6. Filter holder for inline filtration** (e.g. Cat. No. 16254) compressed air
- 7. Airborne microorganism sampler MD8** AirPort and gelatin filters that are placed on the agar | to monitor the air throughout the winery, particularly in the critical areas in the filling area.
- 8. Rapid test equipment** only suitable when the bacterial count is high, for example, bioluminescence can be used to monitor hygiene. Rapid tests are less suitable to detect trace infections. Hygiene monitoring to verify the cleanliness of conveyor belts, and employees' hands and clothes.

### 3.5. Suitable Culture Media for Wineries

#### 3.5.1. Total Colony Count

The spectrum of microorganisms found in wine and its preliminary stage, grape must, differs considerably from the range of species found in water. This is explained by the different environments (pH, available nutrients, inhibiting factors, etc.). The total colony count in wine or grape juice actually refers to these products' specific problem microorganisms.

Wineries generally determine the total colony count during their hygiene testing, whereby the focus lies on the total colony count of aerobic mesophilic bacteria. Areas of application are, for example, the water used for cleaning or monitoring the hygiene of the equipment, containers, empty bottles or the operators' clothes.

For this application, universal culture medium with a neutral pH and sufficient peptone nutrients, but without inhibiting additives, is used. This includes **Standard medium** (with or without TTC), **TGE, Yeast Extract** (particularly suitable for water) or **R2A** (for ultra-pure water).

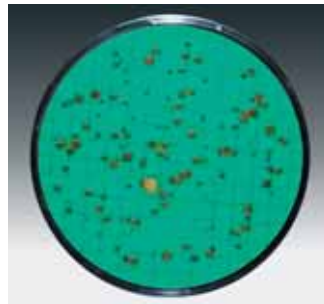

Standard TTC

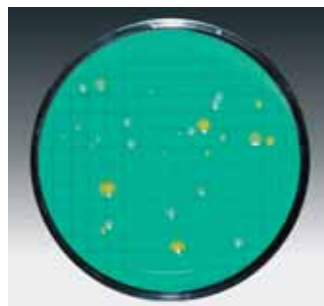

Yeast extract

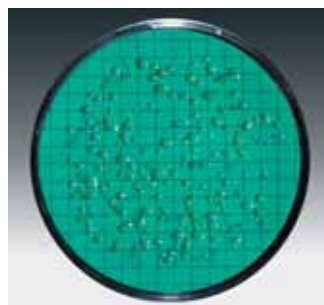

R2A

#### 3.5.2. Yeasts and Molds

The above-mentioned culture media used to determine total colony count are not suitable for the detection of yeasts and molds, even if occasionally colonies of isolated yeasts or molds can be formed. Culture media for yeasts and molds need considerably more nutrients, especially carbohydrates. A low pH is also beneficial. **Wort** and **Malt Extract** are suitable; in some regions, **Wallerstein** is also commonly used.

For the detection of *Brettanomyces*, one of these media to which 20 to 50 mg/l of cycloheximide (Actidione) has been added can be used. This additive efficiently suppresses nearly every type of yeast with the exception of *Brettanomyces* and some strains of *Kloeckera*. Lysine is used to detect wild yeasts, i.e. non-*Saccharomyces* yeasts. Agar-based culture media have a natural pH limitation. At pH values lower than 5, the agar tends to hydrolyze and no longer solidifies. This is why it is better to use carrier materials other than agar as basis of the culture medium, such as cellulose nutrient pads, which are either already impregnated with nutrients or are wetted with nutrient broth. The pH value can thus be adapted to the pH of the product, which, on the one hand, increases the selectivity. This means only the microorganisms that tolerate the product's pH will be able to grow on the media. On the other hand, a low pH prevents the interfering concurrent growth of bacteria of the *Bacillus* genus, which are very similar to the yeast colonies, and therefore often necessitate re-examination under the microscope. This additional task is not required when using acidic media because the bacillus species cannot form colonies in an acidic environment. The only exception to this rule is the acid-tolerant *Alicyclobacillus*, which, however, does not normally occur in wine.

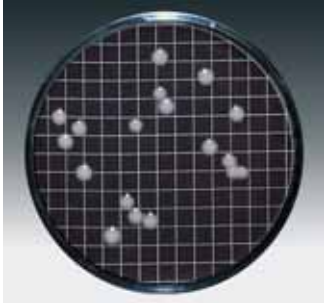

Wort

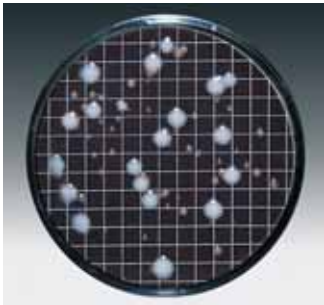

Malt Extract

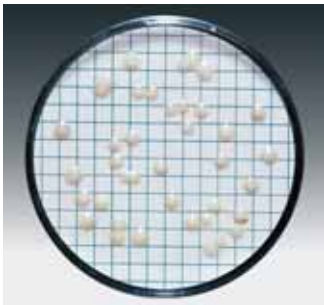

Wallerstein

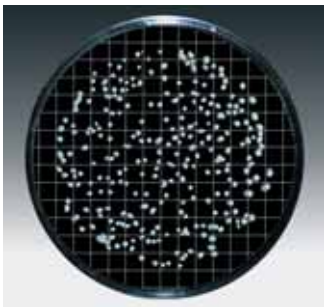

Lysine

### 3.5.3. Wine-spoilage Bacteria

Because wine has a low pH, wine-spoilage bacteria are acid tolerant. For this reason, the culture media used for their detection must also have a low pH.

The most common medium used to detect acid-tolerant bacteria is **Orange Serum**, a medium on which, primarily the acid-tolerant bacteria of the lactic acid bacteria group grow. To detect this group, the culture medium should be incubated under anaerobic to microaerophilic conditions because many of the lactic acid bacteria are inhibited by oxygen. Acetic acid bacteria can also be grown on **Orange Serum**, but should be aerobically incubated. It is also recommended to add 5 to 8% of ethanol to promote their growth and suppress molds. Yeasts and molds can also grow on orange serum, but are suppressed if incubated under anaerobic conditions.

The **Jus de Tomate (Tomato Juice)** culture medium was specifically developed to detect *Oenococcus oeni*, it must be anaerobically incubated for the bacterium to grow well.

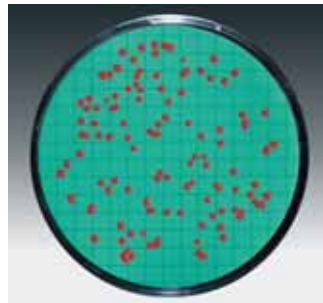

Orange Serum

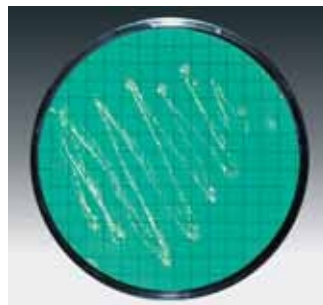

Jus de Tomate (Tomato Juice)

For liquid enrichment, sterile **grape juice** can be used as medium, in which spoilage microorganisms such as yeasts, bacteria and fungi show growth rates equal to those in the finished product.

The semi-liquid agar medium used in the Mayer-Vetsch test is **tomato juice agar**.

### 3.6. The Rapid Test Method

Rapid tests, for performing microbial analyses in minutes or a few hours, are available on the market. Such tests are, of course, particularly attractive, because they eliminate the quarantine period needed for incubation as in conventional microbiology.

However, before choosing a rapid test method, take a close look at how it is conducted and which particular bioburden is suitable to give a reliable result.

#### 3.6.1. Biosensors

The rapid test methods, insofar as they are not pure microscopy tests, are frequently conducted with biosensors. A biosensor is a device that transforms a microorganism's metabolic reaction into a signal that usually can be measured physically. Because they are so small, single microbes only produce minute quantities of metabolites. This is why a larger number of microbes is needed to achieve a measurable result. Pre-incubation for one or more days depending on the type of microorganisms is recommended. If a rapid test method is chosen, please bear in mind that although the test time itself is short as promised, pre-incubation takes up the saved time, meaning that a quarantine period must be observed. The rapid test is hence no longer a true quick test. If pre-enrichment is to be avoided, the detection sensitivity is lowered so much that a positive signal is received only for a few hundred or thousand bacteria per milliliter, which is entirely unsuitable for detecting trace infections in filled bottles. These methods, e.g. the bioluminescence method, which measures the amount of ATP, are restricted to special applications, such as monitoring the fermentation process, or the hygiene inspection of equipment or staff before they start work.

### 3.6.2. Microscopy|Epifluorescence

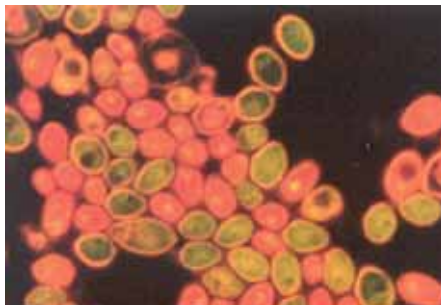

Yeast cells under the epifluorescence microscope

The CFU count can be determined by microscopic examination without incubation time or pre-enrichment. Only relatively high CFU counts can be immediately determined in a counting chamber, making this method unsuitable for monitoring the filled end product. However, the detection limit can be lowered as much as desired when the microorganisms are concentrated on a membrane filter, stained with a dye (usually methylene blue) and directly counted on the filter. A vital stain, such as acridine orange, which also indicates the cells' viability, can also be used. Microscopic examination is definitely recommended when tests need to be conducted quickly. For routine tests, microscopy of an entire membrane filter is far too time-consuming. Yeast cells are easy to detect under the microscope. However, if bacteria need to be counted, evaluation must be very accurate because bacteria are 5 to 10 times smaller than yeast cells and are consequently more difficult to detect.

### 3.6.3. Immunochemical Techniques

Enzyme-linked immunosorbent assay (ELISA) is a well established technique in the medical sector for detecting pathogenic microorganisms. Monoclonal antibodies can be used to correspondingly determine specific product-contaminating microbes in the product. ELISA tests use highly specific antigen-antibody interaction and subsequent coupling to secondary antibody-enzyme-dye complexes. Positive results are indicated by color development, allowing easy visual or colorimetric detection of the target microorganism.

### 3.6.4. PCR and Similar Techniques

PCR is a method that does not involve propagating the microorganisms, but rather replicating their genetic material, DNA. This process is much faster than growing the microorganisms themselves. A short strand of specific DNA is added, i.e., a targeted search is carried out for a specific microorganism. PCR enables specific target microorganisms, such as product contaminants, to be detected in a sample. Gene probes are complementary to typical sections of the DNA of a specific type of microorganism, its genetic fingerprint, so to speak. A staining agent can be attached to a gene probe, enabling the targeted microorganism to be detected under a fluorescence microscope.

### 3.7. Additional Identification Methods

In many cases, routine lab tests end with the findings detected on the culture medium. If necessary, microscopic examination is carried out to confirm that the colony detected really is a yeast colony, or to see whether a bacteria colony shows the typical morphology of, for example, lactic acid bacteria or lactic acid cocci.

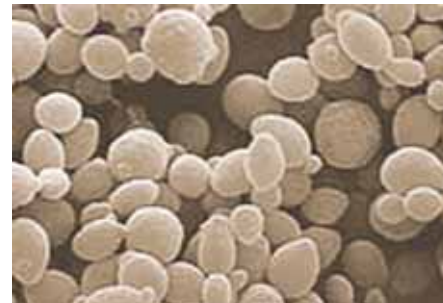

### 3.7.1. Yeasts

Yeasts can be detected under the microscope by their size. In fresh cultures still growing logarithmically, budding is an absolutely reliable indication (unless one is dealing with a representative of the genus *Schizosaccharomyces*).

The exact type of the yeast can be determined by conducting biochemical tests that mainly test the capability of fermenting specific sugars. A variety of easy-to-use test kits are available in lab supply stores. The best-known test kits are API 20 AUX, BBL Mycotube, and RapiD Yeast Plus. Unfortunately, all of these systems have been primarily designed for the medical sector, which is why very few of the typical beverage-spoilage yeasts are represented in databases available for evaluation. The only system that provides a good overview of beverage-specific yeasts is that made by Biolog. The evaluation of its results, however, requires an expensive instrument to measure turbidity, the cost of which is usually not within a winery's budget.

A winery, therefore, frequently limits itself to determining the yeast's fermentability in order to assess risks to its products. This is done by inoculating a yeast colony into sterile grape must and monitoring the samples for growth and gas formation.

**Simplified chart for the rough distinction of wine-spoilage bacteria**

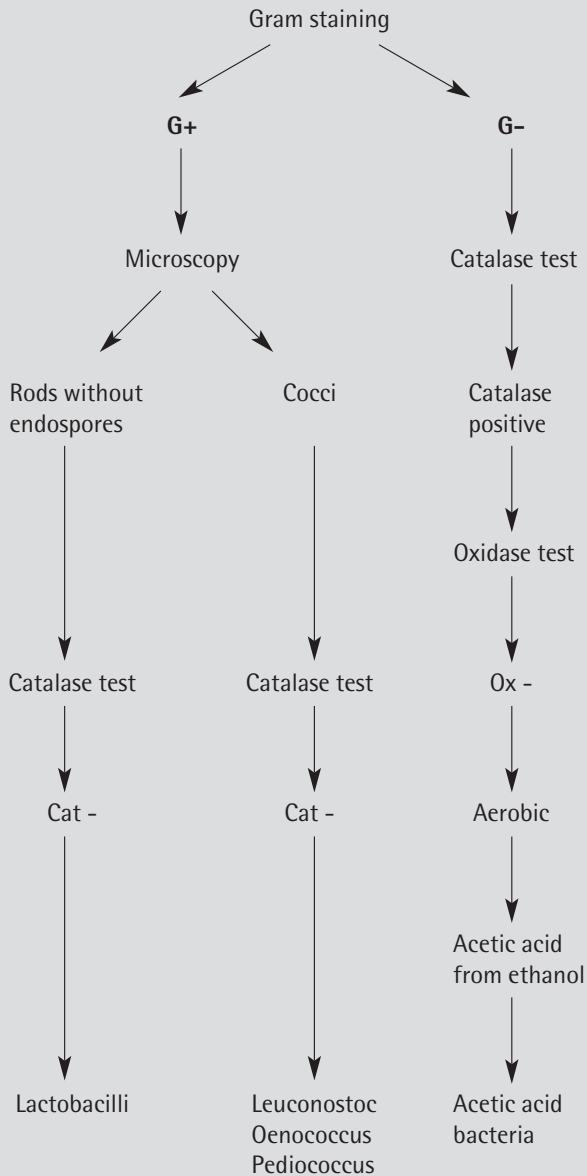

According to Back, modified

**3.7.2. Bacteria**

The main tests used to obtain a rough classification of wine-spoilage bacteria include:

1. Microscopic examination of the cell morphology of cultured colonies – rods or cocci, presence or absence of endospores
2. Gram behavior by means of a potassium hydroxide test
3. Oxidase test
4. Catalase test
5. Aerobic or anaerobic growth
6. Formation of acetic acid from ethanol

Colonies that grow on a bacteria culture must be carefully evaluated to identify the presence of a product spoilage organism or of a commonplace bacterium. This, of course, depends on the medium on which the bacteria colony is found. If a universal medium such as Standard, Plate Count or similar is used, wine-spoilage bacteria will probably not grow because such media cannot fulfill their nutrient requirements. However, if the colony has been inoculated from a culture medium such as Orange Serum, especially after microaerophilic incubation, it is very likely that wine-spoilage bacteria are present, and further testing is required. There are a number of basic and methodically simple tests including microscopic examination, particularly the Gram test and catalase test.

First, the colonies are examined under a microscope to identify whether they are yeasts, bacteria or molds. Bacteria are 5 to 10 times smaller than yeasts, do not bud, and are generally not filamentous like molds. Identification of a "bacterium" under the microscope also reveals whether it is a rod or a coccus. A Gram test is then carried out. The Gram stain targets the structure of the bacterial cell wall. Gram-positive bacteria have a cell wall with a thicker peptidoglycane layer that the Gram stain colors blue. Gram-negative bacteria, on the other hand, have a thinner peptidoglycane layer colored red by the Gram stain. This classic Gram test with staining agents is time-consuming. The much easier potassium hydroxide test can be carried

out instead. This test is conducted by placing two to three drops of a 3% potassium hydroxide solution on a slide and using an inoculating loop to transfer the colony in question. If a filament is formed when the inoculating loop is lifted from the mixture, the colony is Gram-negative. If no filament is formed, the colony is Gram-positive.

A further test is the catalase test, during which the development of oxygen indicates a catalase-positive result and is a sign of aerobic and facultative aerobic growth. A catalase-negative result indicates anaerobic growth. The test is easy to conduct.

Two to three drops of catalase reagent are placed on a colony. If the reaction is positive, the mixture foams considerably. The mixture does not develop foam if the outcome is negative. Beverage-contaminating bacteria are frequently anaerobic, because they grow in closed bottles, whether as rods or cocci. Lactic acid bacteria are catalase negative and Gram-positive. In contrast, acetic acid bacteria are catalase positive, strictly aerobic, Gram-negative rods or cocci. These few tests provide a rough indication whether a colony may belong to the group of wine-spoilage bacteria.

Ready-to-use test kits are also available to identify bacteria. However, here again, most of them focus on medically important bacteria and are frequently not suitable to test for wine-spoilage bacteria.



Evaluation of the plate



Inoculation to a monoculture



PCR in the agarose gel

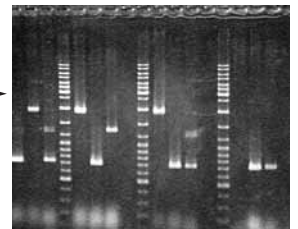

Genome PCR

Accurate subsequent identification using the Biolog System



MycoTube test kit



API 20 Aux test kit



Remel test kit

## 4. Equipment for Routine Microbiological Testing



Three-branch manifold



Single-use funnels on manifold



Water trap (Vacusart)



Biosart® 100 Monitor



Individual filter holder



Biosart® 100 Monitors on manifold



Biosart® 250



Microsart® eJet vacuum pump; is used without a vacuum flask

### 4.1. Stainless Steel Vacuum Filter Holders and Disposables

For large numbers of tests, a three-branch or six-branch manifold is used with 500 ml funnels. The manifold is operated using a laboratory vacuum pump; a flask is connected between the pump and the manifold to collect the filtrate. A water trap (Vacusart filtration unit) protects the pump from condensate.

Vacuum pumps with direct liquid suction are also available on the market. As a result, a vacuum flask is no longer necessary.

For small numbers of tests, an individual filter holder can be used. The filter holders are disinfected between the individual samples via flaming or flaming with alcohol. Other disinfection methods can also be used.

If users wish to avoid the disinfection procedure required for stainless steel funnels, they can go for a single-use option in the form of plastic funnels that are supplied sterile. Actually, the material can even be autoclaved by the user and can be re-used several times, if necessary.



If disinfection is completely out of the question, single-use Biosart® 100 Monitors can be used but must be disposed of after single use. The particular advantage of the Biosart® 100 Monitor is that it can also be used as a sampling vessel. In this case, the plug supplied with the Biosart® Monitor is used to seal off the base and a sample is then taken on-site. Inside the monitor, the sample is safely protected from secondary contamination and can be transported to the laboratory for subsequent filtration. Afterwards, the Monitor is rinsed with sterile water, an ampoule containing the appropriate liquid culture medium is poured into the Monitor to wet the incorporated cellulose pad, the plug is re-inserted, and the Monitor is then converted into a petri dish by removing the filter funnel and replacing it by the lid.

#### 4.2. Membrane Filter Types According to Application

Membrane filters are ideally suited for collecting smallest quantities of microorganisms from large sample volumes, concentrating them and enabling them to grow into visible and countable colonies on suitable culture media.

Bacteria, being much smaller than yeasts, have an average size of approx. 0.2–1 µm 1–5 µm. To reliably collect the smallest wine-spoilage bacteria, a membrane filter with a pore size of 0.45 µm is normally used. By contrast, a filter with a pore size of 0.65–0.8 µm is quite sufficient to retain the larger cells of yeasts and molds.

The membrane filter for colony counting should always be made of cellulose nitrate, as this material offers the best growth properties for the microorganisms.

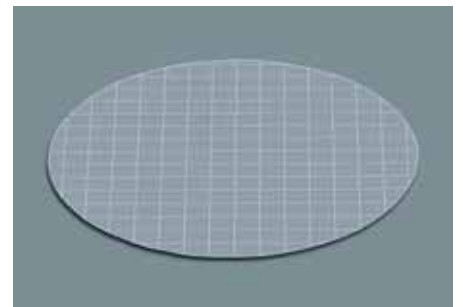
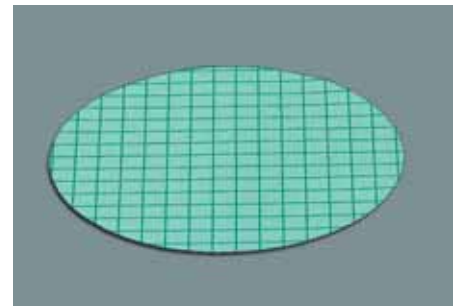
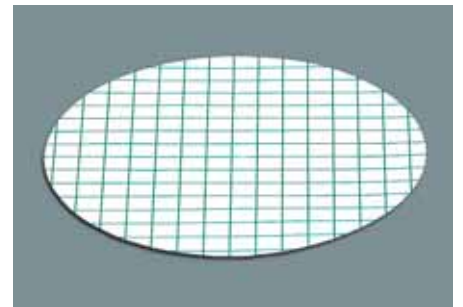

Membranes are available in a variety of colors: green, white and gray. The reasoning behind this is to ensure the best possible contrast between the colonies and the membrane filters, as this makes counting easier. The gray filter is used for examining yeasts and molds that form white colonies in their vegetative state; the green filter, for detecting bacteria on colorless culture media; and the white filter, for detecting bacteria on culture media that enable a differentiation of the colonies formed on the basis of a color reaction.



Nutrient pad set with membrane filter



Nutrient pads in original packaging



Agar media in bottles and tubes for pouring plates



Ampoule with liquid culture medium

### 4.3 Culture Media According to Application

#### 4.3.1. Nutrient Pad Sets

Nutrient pad sets (NPS) are a simple and reliable alternative to culture media. They are sterile, ready-to-use media, already placed in petri dishes, supplied with the matching membrane filters. Hence, there is no need to purchase the filters separately. The shelf life of these media is up to two years from the date of manufacture, endorsed by an absolutely reliable packaging technology that is both lightproof and air-tight and includes a desiccant bag.

To use the nutrient pads, all you need to do is moisten them with sterile water. The sterile water can be added using a sterile pipette. However, it is simpler and more accurate to add the water using a Sartorius dosing syringe equipped with a sterilizing-grade syringe filter. Sterile water can also be added from individual ampoules. An additional advantage is that supplements can be added to the sterile water to make the medium more selective (e.g., Actidion to detect *Brettanomyces*) or to facilitate better growth of certain microbes (e.g. addition of alcohol for promoting the growth of acetic acid bacteria).

Suitable types of nutrient pad sets are available for every routine test required by the wine industry: Wort, Malt Extract, Wallerstein Nutrient and Lysine for detecting yeasts and molds; Orange Serum, Jus de Tomate (Tomato Juice) for identifying wine-spoilage bacteria; and Standard TTC for hygiene testing.

#### 4.3.2. Agar Media

Agar media are available as ready-poured plates, but these are inclined to become unsterile and often have shelf life problems. For this reason, agar is often sold in bottles or tubes and is poured into petri dishes before use.

The types are similar to those of nutrient pads: Wort, Malt Extract, Lysine, Orange Serum, Jus de Tomate (Tomato Juice) and Standard.

#### 4.3.3. Ampoules with Liquid Culture Media

If monitors are used for filtration, the pads inside must be impregnated with liquid culture media, similar to the media types used with nutrient pad sets and agar culture media. In terms of handling, the liquid media easiest to use are those that are provided in sterile, ready-to-use ampoules. One ampoule is used to wet one cellulose pad.

### 4.4 Specific Detection of Microorganisms with Culture Media

#### 4.4.1. Yeasts and Molds

Culture Media:

Wort, Malt Extract and Wallerstein Nutrient are the most important culture media. Other media are also used, e.g., Schaufus-Pottinger (=mGreen Yeast and Mold), Lysine, Orange Serum, etc.

Incubation conditions:

The general recommendation is 2–5 days at 25–30°C under aerobic conditions.

The time period can be modified should a particularly fast growing or slow growing species need to be detected. The temperature can also be varied, depending on the particular requirements of the target microbes. For example, if heat-resistant molds are to be detected, the incubation temperature is increased. In the same way, the incubation temperature is lowered accordingly for psychrophilic organisms. It may be necessary to extend the incubation time, as extreme forms tend to take longer to grow.

Evaluation:

Yeasts normally form white, smooth and shiny colonies. However, in exceptional cases, they are also capable of creating pigments, e.g. *Rhodotorula* takes on a red color. Molds initially grow as white, fluffy, cotton-like colonies. However, as soon as the mold mycelia start forming spores, the color changes to black, brown, red or another color, depending on the spore pigmentation.



As molds sometimes tend to cover the entire plate very rapidly, making quantitative evaluation impossible, it is recommended to check the culture after 2–3 days incubation, then continue with incubation until the desired colony growth has been attained. You can limit mold growth by adding 5–8% ethanol to the medium. This is particularly easy in the case of nutrient pads, as the alcohol can simply be added to the water used to wet the pads.

**Special Remarks:**

To detect special types of yeasts or molds, you may need to supplement the culture medium. For example, the growth of almost all yeasts can be suppressed by adding Actidione (cycloheximide) up to a maximum of 50 mg/l, so that only the resistant yeasts continue to grow: *Brettanomyces* (*Dekkera*) and *Kloeckera*. The latter can even cope with the addition of more than 50 mg/l of Actidione. The pH can also be lowered to suppress undesired growth of bacteria.

Similarly, the addition of antibiotics will achieve this result. For agar culture plates, these substances (sterile-filtered) are added after autoclaving and are mixed into the medium while it is still in a liquid state. If nutrient pads are used, antibiotics can be conveniently added to the sterile water used to wet the pads.

#### **4.4.2. Bacteria**

**Culture Media:**

The media for wine-spoilage bacteria are generally suitable for detecting acid-tolerant microbes. The most important of these is Orange Serum. Wallerstein Nutrient is also used, however, only in the WL Differential version. Jus de Tomate is also particularly suited for detecting wine-spoilage bacteria.

**Incubation Conditions:**

Microaerophilic to anaerobic incubation for 3–6 days is recommended to detect lactic acid bacteria. Incubation may be extended over a longer period in special cases. The temperature is usually 28–30°C. If acetic acid bacteria are to be detected, aerobic incubation conditions must be maintained.

**Evaluation:**

If the medium contains a yeast inhibitor (Actidione), all the colonies that grow will be bacteria, predominantly lactic acid bacteria, if incubation is carried out under anaerobic or microaerophilic conditions. Nevertheless, this result should be confirmed under the microscope. A further biochemical test is necessary for more precise identification (see chart about basic differentiation and section 3.7.2.)

**Special Remarks:**

As with the media used to detect yeasts and molds, the media for testing for bacteria can be made more selective by using additives, or a certain species of microbe can be promoted by adding nutrients or growth-promoting substances (see section 3.5.3.).

# 5. Flow Chart

## Flow Chart of Winemaking

### Grape processing:

#### Grape delivery | wine press

1. Transport containers
2. Collecting vats
3. Conveyor belts | spiral conveyors
4. Destemmer
5. Grape mills
6. Wine presses
7. Short-term heating systems
8. Clarification of mash (flotation, separators, diatomaceous earth filter)
9. Pipes, tubing and connections
10. Pumps
11. Vats and tanks (mash tanks, reservoir and storage tanks)

### Fermentation and young wine:

1. Fermentation tanks
2. Barrique vats

### Wine processing:

#### Delivery

1. Tank truck upon delivery
2. Tank truck after cleaning
3. Connections, pipes and tubing
4. Pumps

#### Cellar

1. Storage tanks
2. Pipes, tubing and connections
3. Pumps
4. Dispensing stations
5. Collection vessels
6. Filter: (inlet and outlet)
  - Depth filters
  - Diatomaceous earth filters
  - Filter cartridges
7. Desulfurization systems

### Fill area:

#### Production areas

1. Bottling area (wet area)
2. Dry area
3. Handling of empty bottles:
  - Bottle rinsers, bottle sterilizers (ozone, SO<sub>2</sub>, steam, chlorine dioxide)
4. Bottles:
  - Empty bottles upon delivery
  - Empty bottles after rinsers or sterilizer
5. Supply tanks
6. Product pump
7. Carbonizer
8. Heat exchanger
9. Product filter:
  - Upstream of the prefilter
  - Upstream of the final filter
  - Downstream of the final filter
10. Automatic sampler (downstream of the final filter or prefilter|final filter)
11. Bottling machine|Filler:
  - Filler heads
  - Infeed and outfeed star wheels (stations)
  - Filter for washdown equipment for glass fragment removal
12. Return (mix zone) and supply tanks
13. Trolleys
14. Sealing machinery:
  - Corking machine
  - Manual corker or roll-on capper
  - Crown corker
15. Filled bottle
  - First fill round
  - Per fill batch
  - Throughout entire production
16. Conveyor belts
  - Bottle conveyor belts
  - Auxiliary material conveyor belts (corks, crown corks, etc.)
17. Auxiliary material storage hopper
18. Media filters
  - Rinse water filter
  - Sterile air filter (O<sub>2</sub>, N<sub>2</sub>, CO<sub>2</sub>)
  - Rinse water filter
19. Filter for washdown equipment for glass fragment removal

### Storage:

1. Conveyor belts for full crates or boxes | trays | BIB | Tetra Paks
2. Goods in storage positions
3. Filled stock storage for damaged bottles | containers.

## Checklist: Grape processing; Microbiological Tests

Grape delivery   wine press	Method	Routine test	Assessment criteria
<b>1. Transport containers</b>			
Empty transport containers	Contact plate   swab test	weekly	< 10 CFU, no yeast
Full transport containers	Swab test	weekly	
Cleaned transport containers	Contact plate	weekly	
<b>2. Collecting vats</b>			
Cleaned collecting vats	Contact plate	weekly	< 10 CFU, no yeast
Filled collecting vats	Swab test	weekly	
<b>3. Conveyor belts   spiral conveyors</b>			
Cleaned	Contact plate	weekly	< 10 CFU, no yeast
During operation	Contact plate	weekly	
<b>4. Destemmer</b>			
Cleaned	Contact plate	weekly	< 10 CFU, no yeast
During operation	Swab test	weekly	
<b>5. Grape mills</b>			
Cleaned	Contact plate	weekly	< 10 CFU, no yeast
During operation	Swab test	weekly	
<b>6. Wine presses</b>			
Cleaned	Contact plate	weekly	< 10 CFU, no yeast
During operation	Swab test	weekly	
<b>7. Clarification of mash: Flotation, separator, diatomaceous earth filter</b>			
Cleaned	Contact plate	weekly	< 10 CFU, no yeast
During operation	Swab test	weekly	
<b>8. Pipes, tubing, connections</b>			
Cleaned	Swab test	weekly	< 10 CFU, no yeast
<b>9. Vats and tanks (mash tanks, reservoir and storage tanks)</b>			
Cleaned	Contact plate   swab test	weekly	< 10 CFU, no yeast
Filled	Membrane filtration	weekly	
<b>10. Short-term heating systems</b>			
	Contact plate   swab test	weekly	

## Fermentation and young wine

<b>1. Fermentation tanks</b>			
Cleaned	Contact plate   swab test	before filling	Test filled tank for bacteria, if no malolactic fermentation is desired
Filled	Sample volume 0.5–1 ml		
<b>2. Barrique vats</b>			
Cleaned	Contact plate   swab test	before filling	Test filled vat for lactic and acetic acid bacteria, possibly for Brettanomyces
Filled	Sample volume 0.5–1 ml		

The values given here depend on the residual sugar content of the wine, the type of wine (white, red or rosé) and the sulfur content. Different values may therefore apply. All three checklists contain only approximate guidelines.

## Checklist: Wine processing; Microbiological Tests

Wine delivery	Method	Routine test	Stage check	Assessment criteria
<b>Unloading station</b>				
<b>Sampling point</b>				
<b>1. Tank truck</b>				
Tank truck upon delivery	0.5–1 ml sample volume	weekly	Each tank truck daily	< 10 CFU
Tank truck after cleaning	1.0 ml sample volume	weekly	Each tank truck daily	
<b>2. Connections, pipes, tubing</b>				
Before cleaning	Swab test	weekly	daily	< 10 CFU
After cleaning	Swab test	weekly	daily	
<b>3. Unloading pump</b>				
Before cleaning	Swab test	weekly	daily	< 10 CFU
After cleaning	Swab test	weekly	daily	
<b>Cellar</b>				
<b>Sampling point</b>				
<b>1. Storage tanks</b>				
After cleaning	Contact plate   swab test	after cleaning	daily	< 10 CFU
Full storage tank	Membrane filter method	when needed	daily	
<b>2. Connections, pipes, tubing</b>				
Before cleaning	Swab test	weekly	daily	< 10 CFU
After cleaning	Swab test	weekly	daily	
<b>3. Feed pumps</b>				
Before cleaning	Swab test	weekly	daily	< 10 CFU
After cleaning	Swab test	weekly	daily	
<b>4. Dispensing stations</b>				
Before cleaning	Swab test	weekly	daily	< 10 CFU
After cleaning	Swab test	weekly	daily	
<b>5. Collection vessels</b>				
Before cleaning	Swab test	weekly	daily	< 10 CFU
After cleaning	Swab test	weekly	daily	
<b>6. Desulfurization systems</b>				
Before cleaning	Membrane filter method	weekly	daily	< 10 CFU, no yeast No yeast / 100ml
After cleaning	Membrane filter method	weekly	daily	
<b>7. Water connections</b>				
Hot water	Membrane filter method	weekly	daily	No yeast / 100ml
Cold water	Membrane filter method	weekly	daily	No yeast / 100ml
<b>8. Water filter</b>				
Air filter	Membrane filter method	weekly	daily	No yeast / 100ml
	Sedimentation method	weekly	daily	Negative

Wine delivery	Method	Routine test	Stage check	Assessment criteria
<b>Cellar</b>				
<b>Sampling point</b>				
<b>9. Filter</b>				
<b>9.1. Filter sheets</b>				
During operation				
Filter inlet	Membrane filter method	weekly	daily, each batch	Depending on retention rate
Filter outlet	Membrane filter method	weekly	daily, each batch	
After cleaning or sterilization				
Filter inlet	Membrane filter method	weekly	daily, each batch	Depending on retention rate
Filter outlet	Membrane filter method	weekly	daily, each batch	
<b>9.2. Diatomaceous earth filter</b>				
During operation				
Filter inlet	Membrane filter method	weekly	daily, each batch	Depending on retention rate
Filter outlet	Membrane filter method	weekly	daily, each batch	
After cleaning				
Filter inlet	Membrane filter method	weekly	daily, each batch	Depending on retention rate
Filter outlet	Membrane filter method	weekly	daily, each batch	
<b>9.2.1. Cartridge filter</b>				
During operation				
Filter inlet	Membrane filter method	weekly	daily, each batch	Depending on retention rate
Filter outlet	Membrane filter method	weekly	daily, each batch	
After cleaning or sterilization				
Filter inlet	Membrane filter method	weekly	daily, each batch	Depending on retention rate
Filter outlet	Membrane filter method	weekly	daily, each batch	
<b>9.3. Crossflow filter</b>				
During operation				
Filter inlet	Membrane filter method	weekly	daily, each batch	Depending on retention rate
Filter outlet	Membrane filter method	weekly	daily, each batch	
After cleaning or sterilization				
Filter inlet	Membrane filter method	weekly	daily, each batch	Depending on retention rate
Filter outlet	Membrane filter method	weekly	daily, each batch	

## Checklist – Bottling (Filling) Area, Microbiological Quality Control

Production areas	Method	Routine test	Result
<b>Sampling Point</b>			
<b>1. Bottling (filling) area</b> Wet and dry area	Airborne microbe collection	monthly	< 500 CFU 100 liters
<b>2. Containers</b> Empty bottles upon delivery	Drip test   MF method	weekly	negative
Empty bottles after rinser or sterilization	Drip test   MF method	weekly	negative
<b>3. Handling of empty bottles:</b> Bottle rinser	Drip test   MF method	weekly	negative
Bottle sterilizers (ozone, steam, SO <sub>2</sub> , chlorine dioxide)	Drip test   MF method	weekly	negative
<b>4. Collection tanks</b> After cleaning or sterilization	Swab test   contact plate	weekly	negative
During operation	Swab test   contact plate	weekly	negative
<b>5. Product pumps</b> After sterilization and during operation	Swab test   contact plate	weekly	negative
<b>6. Carbonizer</b> After cleaning sterilization	Swab test	weekly	negative
During operation	Membrane filter method	weekly	negative
<b>7. Heat exchanger</b> After sterilization	Membrane filter method	weekly	negative
During operation	Membrane filter method	weekly	negative
<b>8. Product filter</b> After sterilization			
Filter inlet, prefilter	Membrane filter method	daily	
Outlet, prefilter   inlet, final filter	Membrane filter method	daily	Depending on retention rate
Filter outlet, final filter	Membrane filter method	daily	Sterile or no yeast
<b>9. Bottling machine (filler)</b> Filling area after sterilization	Airborne microbe collection   Sedimentation method		0 yeast/100 liters
Bottling area during operation	Airborne microbe collection   Sedimentation method		0 yeast/100 liters
Bottling area after filling break	Airborne microbe collection   Sedimentation method		0 yeast/100 liters
<b>10. Filler heads</b> After sterilization	Swab test	min. 1 – 2 per month	negative
During operation	Swab test	min. 1 – 2 per month	negative
After filling break	Swab test	min. 1 – 2 per month	negative
<b>11. Filler return – supply tank</b> After sterilization	Membrane filter method	weekly	negative
<b>12. Trolleys</b> After sterilization	Swab test	weekly	negative
During operation	Swab test	weekly	negative

Production areas	Method	Routine test	Result
<b>Sampling Point</b>			
<b>13. Sealing machine (corker)</b>			
Corker after sterilization	Swab test	weekly	negative
Corker during operation	Swab test	weekly	negative
<b>14. Filled bottle</b>			
First fill round after sterilization	Membrane filter method	1 <sup>st</sup> bottle, during production	no yeast / 100ml
During operation:	Membrane filter method	1 bottle per hour	no yeast / 100ml
In-batch operation:	Membrane filter method	min. 1 bottle / fill batch	no yeast / 100ml
<b>15. Conveyor belts</b>			
Bottle conveyor belts	Swab test   contact plate	monthly	no yeast
Auxiliary material storage hopper	Sedimentation method   cotton swab	monthly	no yeast
<b>16. Media filter</b>			
Rinse water filter after sterilization			
During operation	Membrane filter method	weekly	no yeast / 100ml
Sterile air filter (O <sub>2</sub> , N <sub>2</sub> , CO <sub>2</sub> )	Sedimentation method	weekly	no yeast / 100ml
Rinse water filter after sterilization			
During operation	Drip test	weekly	no yeast / 100ml
<b>17. Water filter for shard washdown equipment</b>	Membrane filter method	weekly	no yeast / 100ml
<b>18. Finished goods storage</b>			
Conveyor belts for full crates, boxes, BIB, Tetra Pak	Contact plate	min. bi-annually	
Goods in storage positions	Contact plate	min. bi-annually	
Filled stock storage for damaged bottles/containers	Contact plate	min. bi-annually	

**Stage check in situations where a contamination in the bottled beverage has been detected:**

All stations from 1 to 18 must be included in the stage checks.

# 6. Cleaning

Cleaning in the Food and Beverage Sector. In order to ensure consistent product quality under food-safe conditions, cleaning has to be performed periodically throughout the whole winery.

The objectives of cleaning are:

- to maintain proper hygienic conditions in buildings, systems and equipment
- to increase the life-cycle of systems and equipment
- to ensure the product quality
- to reduce costs

As most deposits harden over time (aging) and are thus harder to remove, cleaning should be carried out immediately after use. Cleaning the equipment as soon as possible minimizes the risk of microbiological contamination. If production is stopped for a longer period, the equipment must be cleaned before restarting operation.

The cleaning process is divided into the following steps:

- Rinsing of system or equipment
- One or two chemical cleaning processes
- Neutralization
- Final rinse

Most deposits are removed at the rinsing stage. The recommended rinse medium is particle-free DI water.

Chemical cleaning requires careful planning.

The chemicals used must be suitable for loosening and removing the deposits without corroding any components. Additionally, it must be ensured that no residual cleaning agent is left in the system as this could subsequently damage the product. In many cases, ready-formulated cleaning chemicals specially designed for certain cleaning applications are commercially available. The components of these cleaning concentrates are essentially special tensides, acids or bases, complexing agents, enzymes and oxidants.

For each chemical cleaning process, the parameters for the four basic elements of the process,

- Time
  - Concentration of chemicals
  - Temperature and
  - Mechanics of cleaning
- should be set optimally.

Transport mechanisms and chemical reactions need a certain amount of time. Therefore, chemical cleaning should have a duration of at least 30 minutes. In certain cases, it may be favourable to opt for overnight cleaning.

Chemical concentration depends on the type and intensity of the soiling. Please follow the instructions issued by the manufacturers. Usually, a concentration of 1% to 3% is recommended. Beware of the misconception "using a lot helps a lot" - this is a fallacy. If the concentration of chemicals is too high, this may lead to undesirable deposits.

The temperature of the cleaning solution is often a decisive factor for successful cleaning. At higher temperatures, chemical reactions are quicker, viscosity decreases, binding forces are reduced and the speed of liquid flow increases. This means that a temperature increase will usually accelerate the cleaning speed. However, there are unfortunately some exceptions to this rule when selecting the temperature. For enzymatic cleaning, optimum temperatures have to be observed. In the case of protein contamination, the cleaning temperature should not be too high, as this could denature the proteins.

Regarding the cleaning mechanics, the following must be observed: cleaning chemicals must be transported to the location of the soiling. A high flow rate will loosen the deposits via shearing forces. Example: crossflow membrane systems should be run in the recirculating mode with closed permeate outlet, as this will ensure that pressure on the membrane is as low as possible. For static filtration systems (cartridge filtration), the cleaning solution should preferably be applied from the upstream side (in the direction of filtration).

After alkaline cleaning, neutralization with 0.5% phosphoric or citric acid is recommended. This shortens the time needed for the final rinse with water.



The final rinse water must be without flavour and free of foaming after a shake test. The pH value must be neutral.

As cleaning chemicals are often caustic, attention must be paid to appropriate protective equipment during chemical cleaning (goggles, gloves).

In general, the following can be said of cleaning and cleaning agents:

Thorough cleaning will remove all product residues and dirt particles that would otherwise serve as nutrients for microorganisms. Such soiling residues consist partly of organic substances from the wine itself or from the remains of dead microorganisms. These dirt particles also contain inorganic substances. The choice of cleaning agent is therefore also dependent on the residues themselves, as well as the equipment components to be cleaned and their chemical resistance.

Acidic cleaning agents are especially suited for dissolving limescale, tartar and other mineral deposits. Such deposits are a breeding ground for growth of microbial communities, so-called biofilms. Biofilms are very hard to dissolve without leaving residues, so upfront prevention is the better option.

Acetic acid and citric acid, plus their salts, are the basis for most common acid detergents. Their pH values are between 1 and 5. Alkaline detergents are mainly used to remove organic residues such as protein, starch or sugar. These residues also provide a basis for the build-up of biofilms and they must therefore be thoroughly removed. The pH value of alkaline detergents lies between 10

and 14; these agents are based on sodium hydroxide, potassium hydroxide, potassium phosphate and sodium phosphate etc.

Effective disinfection is generally only carried out after cleaning, never before. It is also not advantageous to use a combination of detergents and disinfectants due to potential incompatibilities that may even produce environmentally hazardous chemicals if agents are mixed. As a matter of routine, disinfection should be reserved for the most critical areas and not be carried out throughout the entire winery. In the case of infections, this may have to be reconsidered, if these cannot be eliminated by thorough cleaning. The most well-known and effective disinfectant is peracetic acid, frequently used as a combination formula consisting of peracetic acid, acetic acid and hydrogen peroxide.

In general, every winery should establish a cleaning schedule that is followed on a routine basis. This concept must cover every stage, from the arrival of the grapes through the entire production cycle up to the filled and stored bottles. The cleaning instructions should outline and define all relevant parameters – time intervals, stages, products and methods. This is best represented in a flow chart, similar to the one we have used for the production process in Chapter 5. The success of the cleaning and (where necessary) disinfection measures is to be checked using microbiological tests. This is not mandatory after every cleaning process, but – as defined in the hygiene schedule – such tests should be carried out at regular intervals, depending on the hygienic stability of the entire winery.

## Checklist: Grape Processing Cleaning

Grape processing	Maintenance cleaning	Basic cleaning
<b>Grape delivery   wine press</b>		
1. Delivery vessels	min. daily, hose out down	min. once a week, hose down with detergents and (where necessary) with disinfectants. Rinse out afterwards!
2. Collecting vats	min. daily, hose out down	ditto
3. Conveyor belts   spiral conveyors	min. daily, hose out down	ditto
4. Destemmer	min. daily, hose out down	ditto
5. Grape mills	min. daily, hose out down	ditto
6. Wine presses	min. daily, hose out down	ditto
7. Clarification of mash: Flotation, separator, diatomaceous earth filter	min. daily, hose out down	ditto
8. Pipes, tubing, connections	min. daily, hose out down	ditto
9. Vats and tanks (mash tanks, reservoir and storage tanks)	before filling	
10. Short-term heating systems	min. daily, hose out down	weekly, rinse in pump-out process
<b>Fermentation and young wine</b>		
1. Fermentation tanks		rinse before filling detergent & rinse out
2. Barrique vats		rinse before filling detergent & rinse out (where necessary) with disinfectant

## Checklist: Wine Processing Cleaning

Wine delivery	Maintenance cleaning	Basic cleaning
<b>Unloading station</b>		
<b>Sampling point</b>		
1. Tank truck upon delivery	hose out daily	weekly
2. Connections, pipes, tubing	hose out daily	weekly
3. Unloading pump	hose out daily	weekly
<b>Cellar</b>		
<b>Sampling point</b>		
1. Storage tanks	hose out daily with water before filling	weekly
2. Connections, pipes, tubing	ditto	weekly
3. Feed pumps	ditto	weekly
4. Dispensing stations	ditto	weekly
5. Collection vessels	ditto	weekly
<b>6. Filter</b>		
6.1. Filter sheets	rinse daily or when changing grape type	once/twice weekly, sterilize with steam or hot water
6.2. Diatomaceous earth filter	ditto	rinse, using detergent if necessary
6.2.1. Cartridge filter	ditto	once/twice weekly, oder Heißwasser sterilize with steam or hot water
6.3. Crossflow filter	according to manufacturer's operating instructions	according to manufacturer's operating instructions*
7. Desulfurization systems	according to manufacturer's operating instructions	according to manufacturer's operating instructions
<b>8. Water connections</b>		
9. Water filter Air filter		weekly, sterilize weekly, sterilize
10. Water treatment systems	according to manufacturer's operating instructions	according to manufacturer's operating instructions

\* Once/twice a week, chemical cleaning

## Checklist: Bottling (Filling) Area, Cleaning

Production areas	Maintenance cleaning	Basic cleaning
1. Filling (bottling) area (wet area)	Hose down daily	Once a week, apply floor cleaner
2. Dry area	Hose down daily	Once a week, apply floor cleaner
3. Containers	Hose down daily	Once a week, CIP
4. Handling of empty bottles		
Bottle rinser	Sterilize each morning	Once a week, disinfect depending on type
Bottle sterilizer	Sterilize each morning	Once a week, disinfect depending on type
5. Collection tanks	Daily thermal sterilization	Once a week, CIP
6. Product pumps	Daily thermal sterilization	Once a week, CIP
7. Carbonizer	Daily thermal sterilization	Once a week, CIP
8. Heat exchanger	Daily thermal sterilization	Once a week, CIP
9. Product filter		
9.1. Prefilter	Rinse and sterilize daily	Once a week, CIP
9.2. Final filter	Rinse and sterilize daily	Once a week, CIP
10. Bottling machine/Filler	Rinse and sterilize daily	Once a week, CIP
11. Filler return (mix zone) and supply tanks	Daily thermal sterilization	Once a week, CIP
12. Trolleys	Hose down daily	Once a week, disinfect
13. Sealing machinery	Clean disinfect daily	Mechanical cleaning
14. Filled bottles		
15. Conveyor belts	Hose down daily; clean	
16. Auxiliary material storage hopper; corks, MCA, etc.	Clean daily	Once a week, disinfect
17. Media filter	Daily with steam	
18. Water filter for washdown equipment for glass fragment removal	Sterilize daily	
19. Finished goods storage Conveyor belts for full crates or boxes   trays   BIB   Tetra Paks		Once a month, clean

# 7. Plant Hygiene Training



## 7.1 Plant Hygiene in Grape Processing

The objective of plant hygiene in grape processing is to create optimum conditions for wine making and wine quality.

Healthiness, ripeness of the grapes, weather conditions and picking temperatures have considerable influence on the type and frequency of the hygiene measures to be implemented.



See the checklist Monitoring of Grape Processing and Cleaning

In autumn, microorganisms rarely spread from the grape processing area into the other production areas or into the filling area if these are sufficiently partitioned from each other.



## 7.2 Plant Hygiene in the Production and Cellar Rooms

The objective of plant hygiene in the production and cellar rooms is the hygienic and clean production, processing and storage of beverages under food-safe conditions.

A distinction is made between the following areas:

- Wine delivery
- Tank storage
- Work area
  - centrifuges, filters, desulfurization systems, heat exchangers, pumps, etc.
- Filling cellar



From a microbiological perspective, these areas have to be assessed individually and limit values for bacterial load must be defined plant-specifically. The checklists Monitoring of Wine Processing and Cleaning serve as the basis for an individual definition of the monitoring points.

The various seasons must be taken into account for the monitoring time period and evaluation of the individual areas. The cleaning measures and cleaning intervals and repetitions are based on the respective results of the microbiological testing.

A distinction is made between:

- Maintenance cleaning
- Basic cleaning

Maintenance cleaning takes place during ongoing production operations, and intensive basic cleaning takes place at defined intervals.

In principle, the following must be observed: a cleaning certificate must accompany each tanker delivery. Pumps, pipes, receiver containers, connections and hoses must be regularly cleaned with cold and warm water, sterilized and subjected at regular intervals to CIP cleaning with caustic solution. Storage tanks must be cleaned and, if necessary, disinfected before filling. Regeneration and sterilization of the filters takes place according to the operating instructions of the manufacturer.

The work area should be kept as clean and dry as possible, cleaning lines must be collected into gully lines. No mildew or mold can be tolerated in the production rooms. Infected areas must be treated appropriately or painted with anti-mold paint.

Auxiliary materials and treatment agents should be packaged and stored cleanly and dryly in specially separated rooms or storage areas. Cleaning agents and tools must be stored in a separate room on special collection trays.

Auxiliary media: water, air, CO<sub>2</sub>, nitrogen must be equipped with corresponding filters, regularly regenerated and sterilized.



### 7.3 Plant Hygiene in the Bottling Area

The objective of plant hygiene in the bottling area is the safe and reliable filling of beverages under food-safe conditions.

The filled product and the plant processes in the production chain are subjected to regular microbiological monitoring. The overall production safety is increased when, in addition to the finished product, the product path is also analyzed, and when the effectiveness of the cleaning and/or sterilization of the individual production units is verified microbiologically.

In the production rooms, the analysis focuses on the wet area. In the less sensitive dry area, the analysis intervals can be extended.

Another important point is personal hygiene in the filling area and the behavior of the employees during production. In general, all machines, auxiliary materials and persons in the bottling hall that come into contact with the product must be rated as sensitive.

Of the filled product, at least the first and last bottle and one bottle from the middle of the batch must be taken from every individual filling batch and then analyzed; for larger filling batches, samples must be taken during the entire production at 1-hourly intervals.

The individual hygiene areas in filling are listed and described below. The type of the sample and the analysis method are indicated in the checklists in table form and divided into routine monitoring and staged inspections in the event of microbiological findings.

Following the microbiological assessment of the current situation, an evaluation of the effectiveness of the measures taken should always be performed.

Flow chart: Product path of an automated cartridge filter system



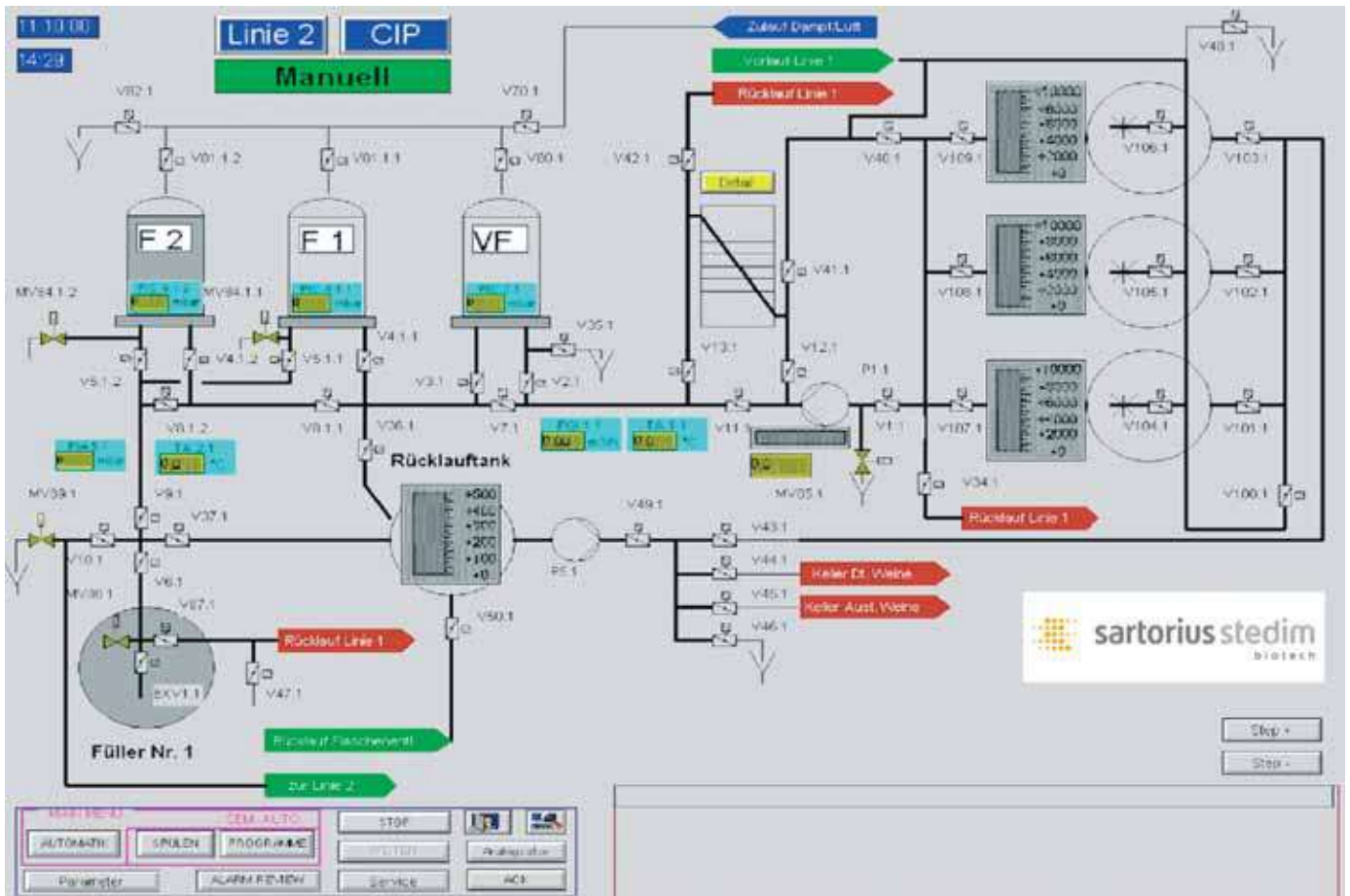

Example: Collecting tank

Machines and units of the product path:

- Collecting tanks
- Pumps
- Wine heating
- Filter system
- Bottling machine (filler)
- Corker

The entire production line, including receiver tanks, pumps, wine heating, filter systems and fillers are subject to a morning routine in preparation for filling and then after filling, an evening routine. The morning routine includes rinsing the production line with cold water and warm water, sterilization with steam or hot water, cooling with cold water and the integrity test of the filter membranes. Following this, the product is added to the filler and the production takes place. The evening routine after production ends, includes pressurized

emptying of the production line with air, followed by regeneration with cold and warm water.

For collecting tanks and pipes as well as fillers, sterilization with steam or hot water, a CIP cleaning with base and subsequent neutralization are required at regular intervals in addition to cleaning with cold and hot water. The feed pumps and the residue drains (sink) must also be inspected.

The bottling machine, or filler, is one of the microbiologically most sensitive units in the production chain. During sterilization of the filler, the temperature and sterilization time at the filler discharge and the filling heads must be regularly monitored and documented. The protective paneling of the filler must always be closed during production, a corresponding inspection of

the ambient air in the filling room should take place regularly. After every shutdown, filling intermission, repair work or other production delay, an alcohol disinfection with 70% ethanol should be performed.

The filler operating personnel and filler maintenance personnel must undergo special hygiene training. In principle, no cleaning work with compressed air, water hose or especially high-pressure cleaners may take place during ongoing production. No openwaste containers are permitted in the filling area. For the sealers, attention must be paid to the temperature of the cork seal heating (if present and if processing of the seal material permits this). Closure supply paths must be kept dry, free of product and must also be sterilized with ethanol.

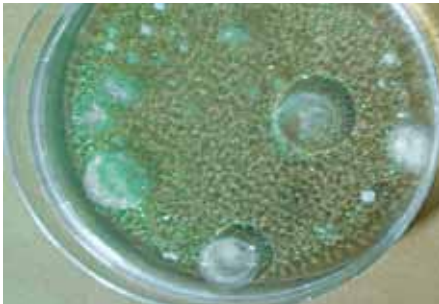

### 7.3.1 Auxiliary Materials

- Containers (bottles, soft packs, etc.)
- Closures (cork, plastic cork, screw top crown cork, etc.)

All auxiliary materials should be stored in dry and undamaged packaging. The filling containers must be clean and free of particles and microorganisms harmful to the product; in order to ensure this, all bottles must pass through the rinser.

### 7.3.2 Units for Filling Preparation, Conveyance and Provisioning of the Accessory Materials

- Rinser
- Conveyor belts for containers, seals, finished packaging, boxes, etc.
- Conveyor belt covers
- Reserve hoppers for closures

For the bottle rinser and sterilizer, depending on the design and type of the bottle sterilization, a morning routine with cold and warm water and subsequent sterilization is generally carried out before filling. The evening routine after production includes cold and warm water rinsing. The concentration of sterilization media (ozone, peracetic acid, chlorine dioxide, etc.) must be checked regularly. For sterile water sprays, the water filter must be equipped with membrane filter cartridges, which must be sterilized and tested for integrity during the morning routine.

The conveyor belt covers should be clean, dry and free from product residue. After the production run, the belt can be cleaned mechanically with an alkaline solution and, if necessary, sterilization with alcohol can take place. Reserve containers for seals must be kept closed, clean and dry.

The floor should be clean and – insofar as possible – dry. In the vicinity of the filler, which is a particularly sensitive zone, the floor should not be hosed down with water or cleaned with a steam blaster to avoid germs spreading via aerosols to the filler. Rinsing lines must lead directly to the gully when possible. During production, no cleaning agents should be used in proximity to the filler.

### 7.3.3 Bottling Hall

All doors must be kept closed. In particular, the doors to the outside area but also those to the workshop area and social rooms. When possible, the bottling hall should be separated from the rest of the production floor. For sterilization with steam, the exhaust should lead out of the production hall.

The bottling hall must be free of insects and other bugs. Insect lamps have proven effective for this. Auxiliary materials may only be stored at the designated storage locations. The objects required for cleaning must be stored in the designated storage locations. The forklift transports are only permitted along the designated forklift paths.

### 7.3.4 Behavior during Production

No eating, drinking or smoking is permitted in the production area. Hands must be washed and disinfected before entering the sensitive production area!

No jewelry may be worn whilst working with open product containers. Hands must be disinfected before working on machines or auxiliary materials that come into direct contact with the product.

Work clothing must be worn, including safety shoes and, in the filling area, a head cover as well.

### 7.3.5 Less Sensitive Areas

- Storage
- Auxiliary materials receiving
- Auxiliary material storage
- Finished products storage

These areas should be clean, dry and free of bugs. Cleaning agents must be stored in appropriate protective trays according to their hazard class.

In all areas, the hygiene status must be monitored at appropriate intervals and with corresponding analysis procedures depending on the sensitivity of the respective area.

Please see section 3.



### 7.4 Procedure in the Event of Microbiological Findings in Filled Product

In ongoing production, a CIP cleaning of the CIP-capable units and subsequent sterilization of the entire production line should take place immediately after detection of an abnormality.

#### Action needed

- Re-inspection of the filled product
- Identification of the microorganisms
- Localization of the source of contamination
- Elimination of the source of contamination
- Subsequent inspection

A subsequent re-inspection of the filled product serves to determine the scope of the damage. Is it a widespread infection, are parts of the filling affected or the entire filling batch or filling day?

#### Sample Volumes for Subsequent Inspection

1. Retention samples
2. Finished goods:
  - At least 1 box per filled pallet
  - Start and end of the filling batch
  - Or 1 bottle every half hour

On identification of the microorganism, see the preceding section.

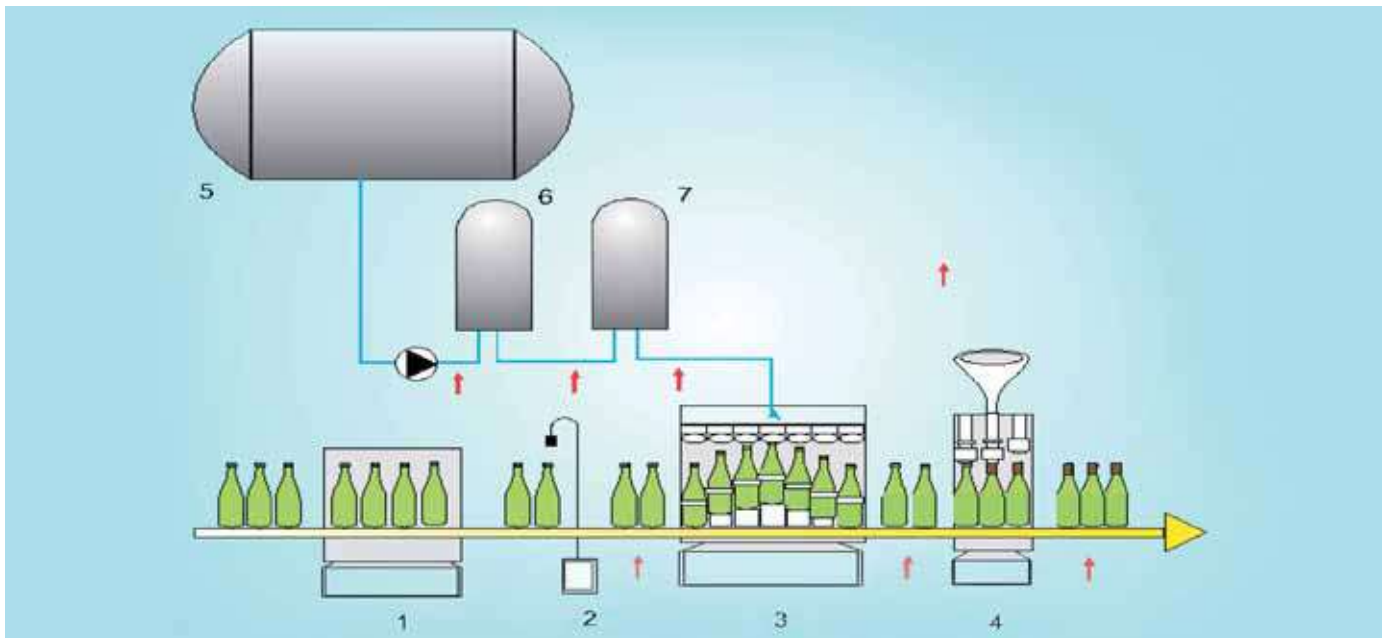

#### Inspection Points

(marked with red arrows):

- 1 Bottle inspection
- 2 Bottle neck sterilization
- 3 Filler (bottling machine)
- 4 Corker
- 5 Collecting tank
- 6 Prefilter
- 7 Final filter

Localization of the damage source through staged inspections: – see checklist –

In cases of severe contamination, causal research in the form of a sample filling is advisable.

Particular attention should be paid to the filler and rinser, which in 60% of the cases cause the contamination. The 1st filler circuit after filling starts gives information about the success of the filler sterilization and how clean the filling valves are. Inspection of the sterilization temperature at the filling valve and filler discharge is also useful.

Sampling from the product line, either from the filter outlet or the filler inlet rules out contamination in the product path line. It is also important to draw samples during the pressurized draining of both the product line and the filter into the filler.

Automatic sampling devices that place several ml of product in a sterile analysis bottle at defined intervals are advantageous; in routine testing they are regarded as a sterile control for the entire production time. Rinser water, rinsed bottles, monitoring of the sealing units and containers as well as defective valves, bypasses and return flow lines in the sterile area of the filler node can also be sources of infection.

**When the source of damage has been localized and eliminated, a further stage check inspection must always be performed as a final test to validate the results.**

## 8. Risk Assessment and HACCP

HACCP is a preventive system that is intended to ensure the safety of foods and consumers.

HACCP stands for Hazard Analysis Critical Control Points. It is a systematic preventive approach intended to accompany the entire production process and to identify potential safety hazards, so that key actions, known as Critical Control Points (CCP's) can be taken to reduce or eliminate the risk of the hazards actually occurring. The goal is to protect the consumers from health risks.

The HACCP concept is based on 7 principles:

1. Conduct risk analysis
2. Identify control points
3. Establish critical limit values
4. Establish monitoring and inspection processes
5. Establish monitoring actions
6. Establish review procedures
7. Establish regulatory documentation

These principles will now be explained in greater detail. However, one should always consider that the concept was originally developed for foodstuffs that could present a health risk for consumers if improperly produced. For one thing, there is the microbiological risk, in other words, the presence of pathogens in the product; for another thing there is the risk of chemical and physical dangers. The microbiological risk is practically nonexistent in the wine industry since microorganisms that are capable of surviving and reproducing in wine do not fall into the category of pathogens. *Listeria* in cheese, *Salmonella* in dried milk or *Clostridium botulinum* in ham on the bone – such dangers are luckily not present in wine.

### 1. Conduct risk analysis

The first step is hazard or risk analysis. This involves identifying all potential hazards of the individual manufacturing process steps that could negatively impact the food hygiene of the finished product.

Every hazard is analyzed and assessed with regard to its significance for food safety as well as the probability of its occurrence. This establishes risk transparency. The result is a list of clearly defined individual risks. This risk analysis should be performed by an interdisciplinary team that is appointed specifically for this purpose. This team creates a detailed description of the product and a flow chart of its typical production cycle at the plant and includes a detailed list of possible risks. This flow chart must be tested for validity by the team through an on-site inspection. Risks to be considered are microbiological risks (in wine, as previously mentioned, insignificant), chemical risks (disinfectants, cleaning agents, pesticides, etc.) and physical risks (glass splinters, metal parts, etc.). The production process must be inspected for potentially problematic environmental conditions, such as bugs, waste disposal, hard-to-clean surfaces, employees with poor hygiene discipline, etc.

The risk group into which the product falls must also be defined; for example "susceptible," "perishable" or "re-heated before consumption". The consumer group for whom the product is intended must also be precisely defined, such as "healthy adults," "diet food" or other target groups. These few examples make clear that risks with regard to shelf life and consumer group are low in combination with the practically nonexistent microbiological risk.

### 2. Identifying Control Points

In this step, the critical control points, or CCPs, at which the identified hazard can be brought under control are identified. This can be a site or working area, such as a cold room or the pasteurizer. It can be a raw material, which may be contaminated with pesticides or other substances. It can be a critical process, such as water softening, or a critical final product that only has limited shelf life due to its pH value or other properties. The determination of the control points is made based on a so-called decision tree. The result must be a complete list of the CCPs. Once this list is drawn up, every CCP should be re-evaluated to determine whether it can be modified in such a way as to remove it from the risk area, making it no longer a CCP. If this is not possible, the risk should at least be minimized.

### 3. Establish Critical Limit Values

After the control points have been identified, the set values and tolerance limits must be determined. This can be done based on physical parameters, such as the temperature (e.g. temperature during fermentation), or chemical parameters, such as the pH value and the level of sulfuric acid content in the wine. Limit values can be defined for such parameters that must be met in order for the product to achieve the desired stability.

### 4. Establish Monitoring and Inspection Processes

For the set values defined under item 3, measurement and testing processes must now be defined that allow for continuous monitoring of every CCP and indicate when it exceeds the established limits. Here, in-process controls should always be preferred over spot sampling.

## 5. Monitoring Actions

If deviations from the set values are discovered during monitoring, the process must be stopped immediately, if possible, and corrective action must be taken before the deviation jeopardizes product safety. To this end, suitable measures must be defined under item 5. This makes it possible to manipulate and effectively master the control point locally. Measures can include, for example, increasing the pressure, cooling or heating, pH modification, etc.

## 6. Establish Review Procedures

To check the efficiency of a system, additional, system-independent monitoring procedures must be established, such as audits, the analysis of random samples by third parties, testing monitoring equipment, the availability of work flow plans, etc.

## 7. Establish Documentation

Records are to be kept of all processes and instructions, written documentation of all findings and occurrences during the planning, construction, application and modification of the system. These also include test procedures, process, sequence and data collection plans, accumulated performance data together with all statistical analyses. A reliable administrative procedure for change notification must be ensured.

In summary, the following can be stated:

A CCP can only be established in a place where process deviations can be measured, e.g. process deviations from a critical limit value. Further, it can only be established in a place where steps can be taken in order to correct this process during ongoing production.

It must be considered here that the focus is on the health safety of the manufactured product and not on the quality of taste, the filling quantity, an undesired odor or suchlike.

In practice, this is handled less strictly in the wine industry, and quality-relevant points are frequently included in the HACCP system, points that do not endanger consumers' health if not complied with (e.g. the filling level of the bottle). Every plant must decide individually on its CCPs.

Below some guidelines for the establishment of CCPs

1. After bottle cleaning. It must be ensured that no residue of alkali or cleaning agents is left in the bottle.
  - Test using pH meter or litmus paper.
2. After cleaning of crossflow systems. Also here, the risk that cleaning agents may not be correctly rinsed out cannot be completely excluded.
  - Test using pH meter or litmus paper.
3. Bottle inspector. Empty bottles that exhibit broken glass or damaged necks must be reliably detected and excluded.
  - Visual check or via optical sensor.
4. Labeling. It must be excluded that, for instance, a bottle or filling series labeled as wine for diabetics contains a product that does not meet these requirements.
  - Visual check or via a scanning device.

Finally, below some experiences and results we have observed during our extensive microbiological analyses in various winery operations.

If excessively high bacterial counts are found, the cause usually lies in insufficient cleaning of the production systems.

Cleaning of tanks is often inadequate. This will result in high bacterial counts in the product, either prior to filling, to the effect that the filter systems block at an early point, or, if there is no sterile filtration, even in the filled end product itself.



Example: Collecting tank

The hygiene of hoses and lines often leaves much to be desired, which can result in correspondingly high bacterial counts.



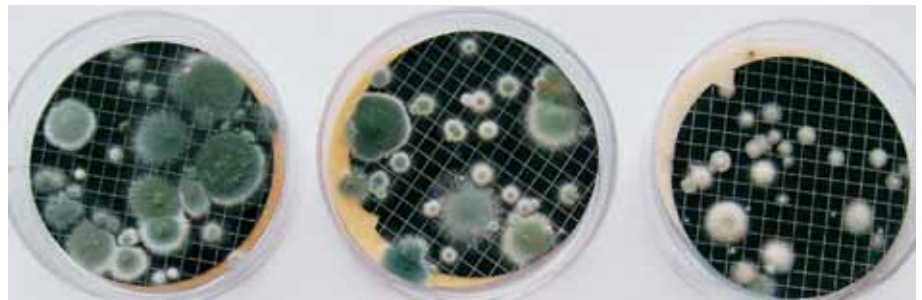
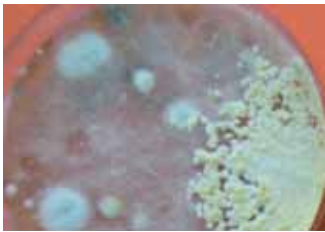

It generally proves practical to place petri dishes with agar or with moistened nutrient pads plus a membrane filter, directly in the filling room and to leave them exposed there for several hours – for instance during a filling shift. This offers a direct correlation to the bacterial load that the filling heads are exposed to. As can be clearly seen from the adjacent images, the bacterial load can vary greatly.

Cleaning is crucial and should be performed according to a cleaning plan that takes the specific conditions of a plant into consideration. Whilst filling is in process, care must be taken not to further increase the bacterial loads in filling room. For instance, measurements have shown that hosing down the floor and the devices results in a multiplication of the airborne bacterial load.

However, most infections stem from the filler or corker. Regular inspection is just as important as cleaning and disinfection. Contaminated filling points will always lead to product alterations as there is no way to avert infection – with the exception of hot filling. Areas such as transport rails for the corks are often neglected during cleaning and inspection, although sometimes high bacterial loads can be detected there.

Only under strictest observation of hygiene control throughout the complete plant, with sufficient sampling and microbiological analysis of the entire process chain, only then can a constant long term quality be assured and errors avoided that can lead to impaired taste and customer complaints.

Note: The controls and practices provided in this brochure are recommendations and guidance for the wine industry. This guidance is not a set of binding requirements.

# Sales and Service Contacts

For further contacts, visit [www.sartorius-stedim.com](http://www.sartorius-stedim.com)

## Europe

### Germany

Sartorius Stedim Biotech GmbH  
August-Spindler-Strasse 11  
37079 Goettingen

Phone +49.551.308.0  
Fax +49.551.308.3289

[www.sartorius-stedim.com](http://www.sartorius-stedim.com)

Sartorius Stedim Systems GmbH  
Schwarzenberger Weg 73-79  
34212 Melsungen

Phone +49.5661.71.3400  
Fax +49.5661.71.3702

[www.sartorius-stedim.com](http://www.sartorius-stedim.com)

### France

Sartorius Stedim Biotech S.A.  
ZI Les Paluds  
Avenue de Jouques – BP 1051  
13781 Aubagne Cedex

Phone +33.442.845600  
Fax +33.442.845619

Sartorius Stedim France SAS  
ZI Les Paluds  
Avenue de Jouques – CS 71058  
13781 Aubagne Cedex

Phone +33.442.845600  
Fax +33.442.846545

### Austria

Sartorius Stedim Austria GmbH  
Franzosengraben 12  
A-1030 Vienna

Phone +43.1.7965763.18  
Fax +43.1.796576344

### Belgium

Sartorius Stedim Belgium N.V.  
Leuvensesteenweg, 248/B  
1800 Vilvoorde

Phone +32.2.756.06.80  
Fax +32.2.756.06.81

### Denmark

Sartorius Stedim Nordic A/S  
Hoerskaetten 6D, 1.  
DK-2630 Taastrup

Phone +45.7023.4400  
Fax +45.4630.4030

### Italy

Sartorius Stedim Italy S.p.A.  
Via dell'Antella, 76/A  
50012 Antella-Bagno a Ripoli (FI)

Phone +39.055.63.40.41  
Fax +39.055.63.40.526

### Netherlands

Sartorius Stedim Netherlands B.V.  
Edisonbaan 24  
3439 MN Nieuwegein

Phone +31.30.6025080  
Fax +31.30.6025099

### Spain

Sartorius Stedim Spain SA  
C/Isabel Colbrand 10-12,  
Planta 4, Oficina 121  
Polígono Industrial de Fuencarral  
28050 Madrid

Phone +34.91.3586102  
Fax +34.91.3588804

### Switzerland

Sartorius Stedim Switzerland GmbH  
Lerzenstrasse 21  
8953 Dietikon

Phone +41.44.741.05.00  
Fax +41.44.741.05.09

### U.K.

Sartorius Stedim UK Limited  
Longmead Business Park  
Blenheim Road, Epsom  
Surrey KT19 9 QQ

Phone +44.1372.737159  
Fax +44.1372.726171

## America

### USA

Sartorius Stedim North America Inc.  
5 Orville Drive  
Bohemia, NY 11716

Toll-Free +1.800.368.7178  
Fax +1.631.254.4253

Sartorius Stedim SUS Inc.  
1910 Mark Court  
Concord, CA 94520

Phone +1.925.689.6650  
Toll Free +1.800.914.6644  
Fax +1.925.689.6988

Sartorius Stedim Systems Inc.  
201 South Ingram Mill Road  
Springfield, MO 65802

Phone +1.417.873.9636  
Fax +1.417.873.9275

### Argentina

Sartorius Argentina S.A.  
Int. A. Avalos 4251  
B1605ECS Munro  
Buenos Aires

Phone +54.11.4721.0505  
Fax +54.11.4762.2333

### Brazil

Sartorius do Brasil Ltda  
Av. Dom Pedro I, 241  
Bairro Vila Pires  
Santo André  
São Paulo  
Cep 09110-001

Phone +55.11.4451.6226  
Fax +55.11.4451.4369

### Mexico

Sartorius de México S.A. de C.V.  
Circuito Circunvalación Poniente No. 149  
Ciudad Satélite  
53100 Naucalpan, Estado de México

Phone +52.5555.62.1102  
Fax +52.5555.62.2942

## Asia | Pacific

### China

Sartorius Stedim Beijing  
Representative Office  
No. 33, Yu'an Road,  
Airport Industrial Zone B, Shunyi District  
Beijing 101300

Phone +86.10.80426516  
Fax +86.10.80426580

Sartorius Stedim Shanghai  
Representative Office  
Room 618, Tower 1, German Centre,  
Shanghai, PRC., 201203

Phone +86.21.28986393  
Fax +86.21.28986392.11

Sartorius Stedim Guangzhou Office  
Room 704, Broadway Plaza,  
No. 233-234 Dong Feng West Road  
Guangzhou 510180

Phone +86.20.8351.7921  
Fax +86.20.8351.7931

### India

Sartorius Stedim India Pvt. Ltd.  
10, 6th Main, 3rd Phase Peenya  
KIADB Industrial Area  
Bangalore – 560 058

Phone +91.80.2839.1963|0461  
Fax +91.80.2839.8262

### Japan

Sartorius Stedim Japan K.K.  
KY Building, 8-11  
Kita Shinagawa 1-chome  
Shinagawa-ku  
Tokyo 140-0001

Phone +81.3.3740.5407  
Fax +81.3.3740.5406

### Malaysia

Sartorius Stedim Malaysia Sdn. Bhd.  
Lot L3-E-3B, Enterprise 4  
Technology Park Malaysia  
Bukit Jalil  
57000 Kuala Lumpur

Phone +60.3.8996.0622  
Fax +60.3.8996.0755

### Singapore

Sartorius Stedim Singapore Pte. Ltd.  
10, Science Park Road, The Alpha  
#02-25, Singapore Science Park 2  
Singapore 117684

Phone +65.6872.3966  
Fax +65.6778.2494

### Australia

Sartorius Stedim Australia Pty. Ltd.  
Unit 5, 7-11 Rodeo Drive  
Dandenong South Vic 3175

Phone +61.3.8762.1800  
Fax +61.3.8762.1828